

HR-400-R1

HEAVY RESERVE PARACHUTE

BY PERFORMANCE DESIGNS, INC.



1300 E. International Speedway Blvd. DeLand, FL 32724
TEL: 386.738.2224 www.performancedesigns.com FAX: 386.734.8297

TMAN-005 - AUG 2005 - REV 0

CONTENTS

SECTION 1: INTRODUCTION

CONTENTS.....02
WARNING AND DISCLAIMER.....06
PARACHUTE PACKING/DEPLOYMENT LOG.....07

SECTION 2: PARACHUTE MAINTENANCE AND REPAIR

RESERVE PARACHUTE INSPECTION.....10
ATTACHING THE RESERVE TO THE RISERS.....14
ATTACHING STEERING LINES TO TOGGLES.....16
CLEANING THE PARACHUTE ASSEMBLY.....20
REPAIR LIMITATIONS.....24
BASIC PATCH.....26
LINE REPLACEMENT.....34

SECTION 3: PACKING INFORMATION

REPACK CYCLE.....38
PACKING INSTRUCTIONS FOR HR-400-R1.....40



SECTION 4: DRAWINGS

TOP DRAWING PACKAGE.....	100
DAMAGE CHART.....	104



(PAGE INTENTIONALLY LEFT BLANK)

SECTION 1:
INTRODUCTION

WARNING AND DISCLAIMER

It is beyond the scope of this manual to teach you how to deploy, fly, land, or maintain this parachute. This manual is only a general guide about this parachute. It is not a replacement for proper training and instruction.

Parachute systems sometimes fail to open properly, even when properly assembled, packed, and operated. There is a risk of equipment damage, serious injury, or death each time this system is used.

Each time you use this parachute you risk bodily injury and death.

You can substantially reduce this risk by: **(1)** assuring every component of the parachute system has been assembled and packed in strict accordance with the manufacturer's instructions. **(2)** by obtaining proper instruction in the use of this parachute and the rest of the equipment, and **(3)** by operating each component of the system in strict compliance with the owner's manual and safe parachuting practices.

STATEMENT OF COMPLIANCE

The policies contained herein comply with the Federal Aviation Regulations, Part 21.

REVISION LIST

Performance Designs, Inc (PD) may revise this manual at any time. The only way to be sure this manual is current for your parachute is to check periodically with PD or check www.performancedesigns.com. PD welcomes suggestions of ways to improve this publication. If you feel parts are incomplete or hard to understand, please let us know by writing or emailing PD. Copyright 2005, Performance Designs, Inc.

DISCLAIMER NO WARRANTY

Because of the unavoidable danger associated with the use of this parachute, the manufacturer makes no warranty, either expressed or implied. It is sold with all faults and without any warranty of fitness for any purpose. The manufacturer also disclaims any liability in tort for damages, direct or consequential, including personal injuries resulting from a defect in design, material, workmanship or manufacturing whether caused by negligence on the part of the manufacturer or otherwise.

By using this parachute assembly, or allowing it to be used by others, the user waives any liability of the manufacturer for personal injuries or other damages arising from such use.

PARACHUTE PACKING/DEPLOYMENT LOG

As any conventional ram air reserve is repeatedly handled and repacked, the fabric permeability will increase. This increased permeability will affect opening, flight and/or landing characteristics. To monitor this important issue, we have incorporated a tracking and inspection program into our reserve canopies. Compliance with this program is mandatory. Each time the reserve is inspected and packed, a single diagonal line \ is to be placed in the next open box on the label. In the event of an actual deployment, an X is to be placed in the next available box.

The warning label should accurately reflect the repacks and uses on that reserve parachute. In the event a rigger encounters a discrepancy between the packing data card and the warning label, the label should be brought into compliance, just as the rigger would do with any other piece of equipment. The owner of the reserve



should be informed that the rigger is simply complying with Performance Designs' requirement for the label to accurately reflect the repacks and/or uses on that parachute.

After 40 repacks or 25 deployments have been reached, the reserve must have its permeability tested. (In most countries, 40 repacks are usually performed over a 10 to 20 year period.) The testing is performed to insure that the fabric permeability has not reached a point where the openings and landing performance would be unacceptable. Subsequent to passing this testing, an additional label is affixed and the parachute is then returned into service. The label will contain additional boxes, the specific number being chosen according to the results of the test.



(PAGE INTENTIONALLY LEFT BLANK)

SECTION 2:
PARACHUTE MAINTENANCE AND REPAIR

RESERVE PARACHUTE INSPECTION

OVERVIEW

The Performance Designs reserve parachute must be inspected thoroughly before its first pack and before each subsequent repack. This inspection should be performed with even more care and attention when first assembled and after a deployment. A certificated rigger must inspect the new Performance Designs reserve and determine its compatibility with your rig. This inspection should be done in a clean, well-lit area with enough room to spread out the reserve parachute.

The following is the Performance Designs recommendation for reserve parachute inspection. Consult the owner's manual for the harness and container and other components for instructions for inspection.

VISUAL INSPECTION

TOP SURFACE

Spread the parachute out on its bottom surface and inspect the top surface starting at the front of the left end cell. Check half of the cell from nose to tail. Then check the other half from tail to nose. Repeat this pattern until each cell's top surface has been inspected. Look for rips, stains, snags, burns, abrasions or failed seams.

BOTTOM SURFACE

Turn the parachute over and spread it out to inspect the bottom surface. Again use the procedure of inspecting half-cells as on the top surface. Check for rips, stains and failed seams. Look very closely at the line attachments. Even slight damage is cause for rejection in these areas. Line attachments must be completely free of any damage or defects. Check under the ends of the line tabs.

RIBS

Inspect each rib from leading edge to the trailing edge by looking inside each cell. Pay extra attention to the line attachment points. Check for items such as burns, tears, seam integrity and pulled threads. Also check the cross ports.

STABILIZERS AND LINE CONNECTIONS

Lay the parachute neatly on one side, stacking each loaded rib on top of the others. Verify that the left and right mirror-imaged lines are of the same length. Check that the trim differential between each line group is correct for this reserve. Check the condition of the stabilizers and slider stops on the stabilizer.

SUSPENSION LINES

Check the full length of each line for damage and wear. Look for fraying at all cascades and where each line attaches to the connector link. Check that all lines are sewn and that the stitching is good. Check the continuity and routing of each line.

SLIDER

Ensure the fabric is not torn, the grommets are undamaged with no sharp edges, and that they are securely attached to the slider. Be sure every suspension line and both steering lines pass through the proper grommet on the slider.



RISER AREA

Visually check the link and its condition. If the link is not bent, cracked or damaged, the link is ok for continued service.

PROTECTIVE LINK COVERS

Insure that the protective link covers located on the connector links are the correct ones, are positioned correctly, are in good condition and are properly secured with tacking cord.

TOGGLES

The toggles must be installed correctly and must match the guide ring and the hook and loop fastener on the risers. Performance Designs canopies come with brake settings and toggle tie on marks set for PIA standard riser/brake dimensions. This standard calls for 4 inches (10.2 cm) from the top of the riser to the top of the brake-setting ring. If the risers are more than 1 inch or (2.5 cm) different from this standard the parachute must be modified. This modification may only be done by Performance Designs, Inc. In addition, any changes must be marked on the parachute's data panel.

FABRIC TESTING

STRENGTH

Performance Designs recommends that a random sample of 10% of all reserves placed in service within your organization be strength tested once per year. A minimum of 3 per year should be tested if the inventory is less than 30 parachutes. If a failure occurs during one of the tests, the cause of that failure shall be determined. If the cause of fabric failure is due to an isolated event (i.e. acid contamination or a cigarette burn), then the testing may be continued at the 10% level. If the cause of the failure is undetermined, contact the manufacturer for further guidance on further testing and any other required actions. The environment in which the parachute has been used may have a significant effect on the strength of the fabric (i.e., desert sun, salty conditions).

Use commercially available 1-inch (2.5 cm) wide fabric testing clamps with rubber-faced jaws and appropriate scale. The scale should be calibrated at least once per year and be accurate within 1.0 lb (0.45 kg). The clamps should be free of any burrs or rough edges that could snag the fabric.

Three fabric strength tests should be performed on each of the following locations on the parachute:

- left end cell, top surface
- right end cell, top surface
- center top surface near trailing edge

The test should never be done where any part of the fabric involved in the test is within 3 inches (7.6 cm) of any seam or the data panel. The test should be done chord-wise. An additional test must be performed on any stained or discolored areas.

Attach the locking fabric clamps to the ripstop fabric. The distance between the clamps should be 3 inches (7.6 cm) and the clamps should be aligned so that the ripstop pattern is parallel to the edge of the jaw.

Lock the clamps securely to avoid slippage. Pass a short length of cord through the eye of one clamp and secure to the packing table or other object that will allow a 30 lbs (13.6 kg) load without movement.



Pass the hook from the spring scale through the other eye and apply a 30 lbs (13.6 Kg) load for 3 seconds.

PERMEABILITY

The permeability of the fabric is very important. As the permeability increases, the parachute will open more slowly and flight performance will deteriorate. The rate of descent will increase and the forward speed will decrease. The ability of the parachute to flare to a soft landing will decrease.

To ensure the parachute is safe to use, Performance Designs has established an average permeability limit of 8.0 cfm for the reserve parachute throughout its service life.

Fabric permeability does not change while the parachute is packed; it changes because of use, packing and handling. That's why it is important to maintain a complete history of the parachute.

Fabric permeability must be tested if any of the following events occur:

- The parachute is completely submerged in water.
- 25 jumps have been made on the parachute since it was new or last certified.
- The parachute has been repacked 40 times since it was new.
- The parachute has an unknown number of jumps, repacks, or there is reason to believe that jumps or repacks were not properly logged.
- Flight performance appears to be substandard.
- There are other reasons to believe the fabric permeability may exceed specifications.

The Performance Designs factory is equipped to perform permeability testing. It is recommended that any parachute needing such testing be returned to the factory.

MAINTENANCE AND REPAIRS

Information on maintenance, repairs and associated limitations may be found in the chapter entitled "Repair Limitations."



ATTACHING THE RESERVE TO THE RISERS

ATTACHING THE RESERVE TO THE RISERS

OVERVIEW

When assembling a Performance Designs parachute onto risers it is important that the directions are followed precisely. The first time you perform an installation, it should be under supervision. If these directions are followed correctly, and only parts supplied by Performance Designs are used, these links will provide excellent service.

CONNECTOR LINKS

Remove all grease and dirt from links, using a solvent that will leave no residue. Trichloroethylene or electrical contact cleaner is recommended.

Inspect the links carefully. Check for nicks, burrs and any sign of bending or stress. Check to be sure the barrel will screw down at least 2-3/4 turns from first engagement with no resistance.

If the bumpers are not already installed, slide them over the links and onto the lines. You can use a pull up cord to assist you in doing this.

Attach the connector links onto the risers and tighten the links - finger tight.

Perform a thorough line continuity check at this point, making sure that the parachute is rigged correctly.

Tighten the link finger tight and torque to 20-30 in lbs-force (2.26 – 3.39 Nm). To accurately gauge this, place a 5 lb. (2.27 kg) weight on a wrench, 5 inches (12.7 cm) from the link. When the wrench is horizontal and the barrel no longer turns, the link is fully tightened. Do not tighten more than 30 in lbs-force (3.39 Nm).



ATTACHING STEERING LINES TO TOGGLES

ATTACHING STEERING LINES TO TOGGLES

OVERVIEW

The following contains instructions on toggle attachment. The HR-400-R1 is manufactured with a finished loop at the end of the steering line for toggle attachment. Performance Designs recommends the following method.

PROCEDURE

NOTE: Prior to hooking up the steering toggles, make sure the steering line passes through the grommet on the slider.

Route the steering line through the guide ring located on the riser.

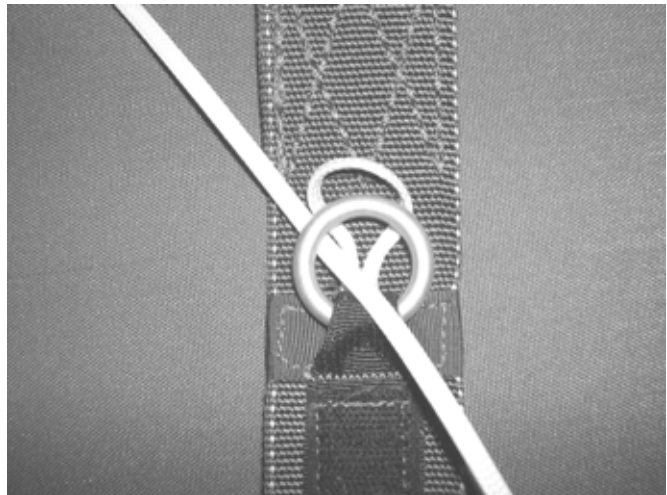

Push the finished loop through the back of the toggle.

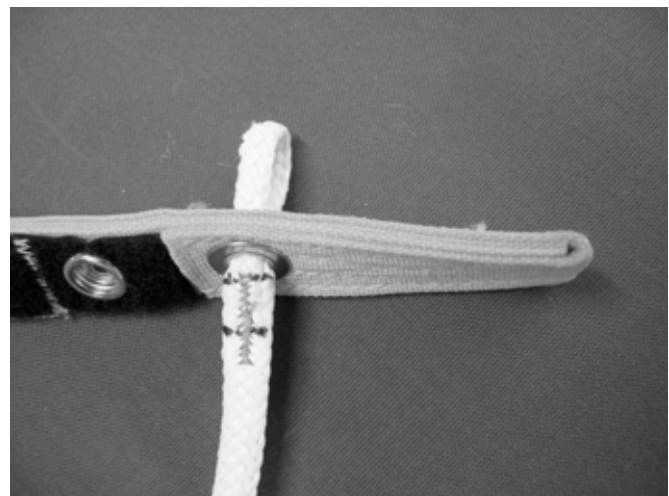

Thread the toggle through the finished loop creating a lark's head knot. Do not thread the upper end of the toggle through the loop because this is not a secure method and may come off.



Pull the toggle completely through and tighten the knot around the toggle.



(PAGE INTENTIONALLY LEFT BLANK)

CLEANING THE PARACHUTE ASSEMBLY

CLEANING THE PARACHUTE ASSEMBLY

OVERVIEW

Washing a parachute is not recommended unless deemed absolutely necessary. Washing a parachute can weaken and/or increase the permeability of the fabric. Washing can also cause shrinkage in the nylon fabric, tapes and the cotton/Nomex® components (i.e., bridle attachment area). Do not dry clean parachutes. Parachute components may be spot cleaned or cleaned as a unit and care must be taken that the cleaning process does not do more damage than the original soiling.

This chapter also covers identification and removal of some types of contamination. Items such as acid, salt water, and petroleum products are covered.

HANDWASHING (IF ABSOLUTELY NECESSARY)

1. A mild soap or soap solution, and a water softener may be used.
2. Immerse the parachute into clean, fresh water contained in a smooth vessel, such as a bathtub.
3. Do NOT wring the parachute fabric. Damage to fabric permeability will result.
4. Gently move items by hand until all air pockets are removed. Agitate as little as possible or damage to fabric permeability will result.
5. Empty the vessel of dirty water and refill with fresh warm, clear water.
6. Rinse the parachute several times in warm, fresh water until rinse water is clear.

DRYING A PARACHUTE

The procedure for drying a parachute is as critical as the procedure for washing it. Asymmetric shrinkage may occur if the parachute is dried unevenly.

1. Remove pilot chute assembly and/or drogue/slider control line.
2. Hang parachute full-length or the seams may experience uneven shrinkage creating a turn in the parachute.
3. Hang reserve parachute assembly by all four connector links for the same time.

ACID CONTAMINATION

Nylon that has been contaminated by acid may have irregular shaped spots of gray or dead white color. The acid-contaminated fabric may also become powdery when scraped lightly.

Parachute components suspected of acid contamination may be tested with blue litmus paper. Dampen the suspect area with distilled water. Then lay the litmus paper on the area in question. If the paper turns pink, acid is present. Be careful not to touch the litmus paper. Touching the paper can cause an erroneous response.

If an area tests positive for acid and the effected area is known to be localized, that area should be neutralized with a solution of distilled water and ammonia. Household ammonia will work. Ammonia will not damage nylon or hardware. The damaged area should be removed and the resulting hole should be



patched. If the extent of contamination cannot be determined or if it effects large portions of the parachute, the parachute should be first destroyed then disposed of.

REMOVAL OF SALT WATER CONTAMINATION

Crystals of dry salt and the presence of pale brown, circular stains often evidence salt-water exposure. If the parachute is allowed to dry after salt-water immersion without being rinsed in fresh water, salt crystals will form causing damage to the fabric and suspension lines.

1. Parachutes exposed to salt water should be rinsed out several times in warm, fresh water in a smooth tub. Use of a water softener is recommended. Hang assembly in drying tower in accordance with the section above entitled "Drying a Parachute."

The maximum complete salt-water immersion limits for the parachute are listed below. The parachute assembly should be cleaned within 8 hours of immersion.

Remove from service any parachute assembly or sub-assembly for any of the following conditions:

1. Immersion in salt water for more than 6 hours if the parachute contains cadmium-plated parts.
2. Immersion in salt water for more than 24 hours if the parachute contains stainless steel parts (i.e., slider stops).
3. Immersion in salt water and cannot be cleaned for 36 hours.

REMOVAL OF PERSPIRATION

Perspiration causes damage to the parachute much like salt water does. Small amounts are not significant and may be ignored. For larger areas heavily contaminated, clean the parachute in accordance with the "Removal of Salt Water Contamination" section above.

REMOVAL OF FRESH WATER

Dry parachute assembly in accordance with the section above entitled "Drying a Parachute."

REMOVAL OF MILDEW

1. Wash affected area with mild soap and water solution.
2. Rinse affected area thoroughly with fresh, clear water.
3. Hang assembly in drying tower in accordance with the section above entitled "Drying a Parachute."

REMOVAL OF FIREFIGHTING AGENTS

Parachute fabric and webbing exposed to light water, protein foam, PKP, and any combination of such shall be thoroughly washed within 30 hours after exposure. Hang assembly in drying tower in accordance with the section above entitled "Drying a Parachute."

Metallic parts or components so exposed shall be disassembled as far as practical, washed, dried, and examined. Metallic components treated in this manner may be returned to service if undamaged.

Remove from service any parachute assembly or sub-assembly for any of the following conditions:



1. Contamination by soda-acid firefighting agent. Hardware items may be returned to service after cleaning.
2. Contamination by firefighting agents such as light water, protein foam, PKP or any combination of such, if not decontaminated within 30 hours. Hardware items may be returned to service after cleaning.

REMOVAL OF PETROLEUM PRODUCTS

Hydrocarbons usually do not harm nylon. Petroleum products such as oil or grease have a greenish or brownish appearance. Wash affected area by repeated applications of mild soap and water solution. Each application shall be followed by a rinse in clean, fresh water.

1. Continue washing and rinsing affected area until clean.
2. Hang assembly in drying tower in accordance with the section above entitled "Drying a Parachute."

REMOVAL OF BLOODSTAINS

1. Soak the stained area in cold water.
2. Hand wash affected area with mild soap and water solution.
3. Rinse affected area thoroughly with fresh clean water.
4. Hang assembly in drying tower in accordance with the section above entitled "Drying a Parachute."

REMOVAL OF SOIL

1. Hang the parachute and shake to remove most of the dirt and sand.
2. Brush lightly with a soft-bristled brush.
3. If the assembly is extremely contaminated, perform the following:
 - a. Wash only the soiled areas in warm water with a mild soap.
 - b. Rinse affected area thoroughly with fresh clean water.
4. Hang assembly in drying tower in accordance with the section above entitled "Drying a Parachute."



REPAIR LIMITATIONS

REPAIR LIMITATIONS

OVERVIEW

This section contains some limitations to adhere to when performing parachute repairs.

REPAIR QUALIFICATIONS

Minor Repairs - a senior rigger or country's equivalent may perform minor repairs.

Major Repairs - a master rigger or country's equivalent may perform major repairs.

Factory Repairs - these repairs may only be performed at the PD factory. These include all repairs that are not specifically listed as minor or major repairs.

PATCHES

Holes or snags smaller than the size of one ripstop box (1/8 inch, 3.2mm) may remain unrepaired as long as no more than one hole exists within any 10-inch (25.4cm) circle. A maximum of three such holes or snags per cell are allowed.

Ripstop tape is not authorized for use on Performance Designs reserve parachutes. If the damage is enough to warrant a repair, a sewn repair must be performed.

Darning is not a means of repairing Performance Designs parachutes.

Any hole or tear up to 10 inches (25.4 cm) in length may be repaired by a senior rigger as long as the closest area of the completed repair is at least 1 inch from the nearest seam and at least 5 inches from the nearest tape or line attachment. These are minor repairs.

LINES

Any line, tape, or webbing damage is a major repair.

A master rigger may replace lines. However, it is recommended that the factory do these repairs.

Master riggers may perform repairs that do not involve taking apart any bartacks on the parachute. Special bartack patterns are used that are not normally found in the field. In addition, removal and replacement of these stitch patterns usually weakens the fabric to the point that it is necessary to replace the portions of panels. The original templates are needed to complete this correctly.

GENERAL

Reserves may only be repaired using certified materials. All replacement materials must come from the Performance Designs factory. Under-strength thread and fabric is frequently found in the field. The only way to be sure the material meets Performance Designs standards is to obtain them directly from Performance Designs.



BASIC PATCH PROCEDURE

BASIC PATCH PROCEDURE

OVERVIEW

The Raghanti Basic Patch is recognized as the preferred patching method throughout the industry. The patching method does not require pins nor does it require a measuring square.

The Raghanti Basic Patch can be made in almost any size as long as it falls within the limitations for patches (listed in "Limitations" section below). This chapter will focus on a 6-inch practice patch as the example. This size patch may be used to repair small damage to the parachute. "Small damage" would be approximately 2 square inches (5.08 sq cm) in size.

LIMITATIONS

A senior rigger (or country's equivalent) is qualified to repair any damage up to 10 inches (25.4 cm) in length as long as the closest area of the completed repair will be:

- At least 1 inch (2.54 cm) from the nearest seam, and
- At least 5 inches (12.7 cm) from the nearest tape or line attachment.

Small snags and holes smaller than 1/8-inch square (one ripstop box) located further than 10 inches (25.4 cm) from the closest line attachment may remain unrepaired as long as there are no more than one in any 10-inch (25.4 cm) diameter circle. A maximum of three such snags per cell are allowed.

Ripstop tape is not authorized for use on Performance Designs reserve parachutes. If the damage is enough to warrant a repair, a sewn repair must be performed.

EQUIPMENT AND SUPPLIES NEEDED

- Marking pencil
- Single needle sewing machine with "E" thread
- Ruler
- 7-inch (17.8cm) square piece of fabric for the patch
- 13-inch (33 cm) fabric piece (on which to sew the practice patch)
- Hemostat
- Scissors
- Nippers



PROCEDURE

Locate the damage on the fabric (ex. circles and lines in the photograph). Once the damage has been identified, draw a box around it to define the damage area. The boundary for this particular area of damage is approximately a 2-inch square.

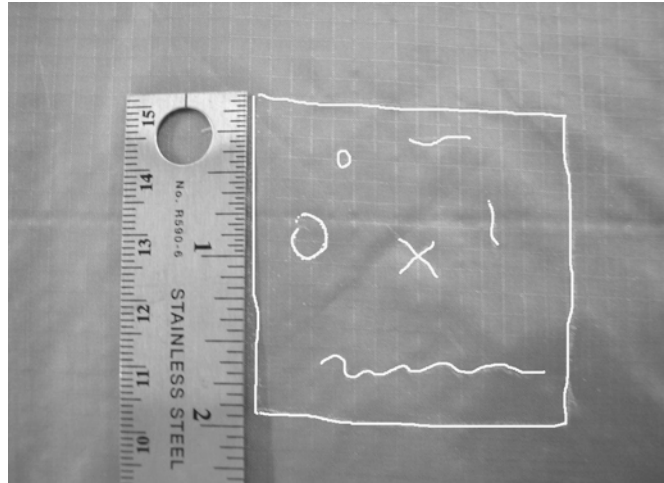

Find the center of the damage and mark it with an "X".

Allow approximately 2_ inches from each boundary side for repair work. This includes a _-inch seam allowance.

Measure half the patch size (in this case, 3 inches) to the left of the damage center. Follow one rip stop line in the fabric as a guide.

At 3 inches out make a center and left border mark (resembling a "T" turned 90° counterclockwise). The center mark will be on the ripstop line (which was followed out 3 inches) and the left border mark will be perpendicular to the center mark. Go 3 inches up from the left center mark and place a top left corner mark.

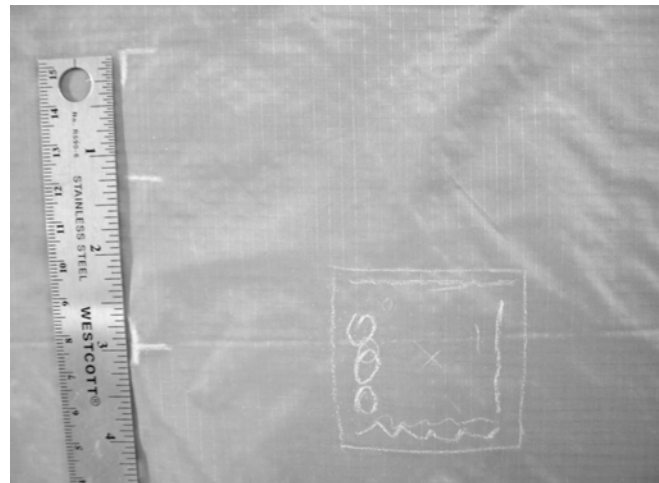

Count down 10 ripstop boxes from the top border and make a mark. This is the starting point.

Count 14 rip stop boxes down on the 7-inch fabric (patch) piece and make a mark. This is the starting point.

Align the starting marks on both pieces of fabric.



Fold the patch material under four ripstop boxes. Hold this 4-block seam allowance with the hemostats.

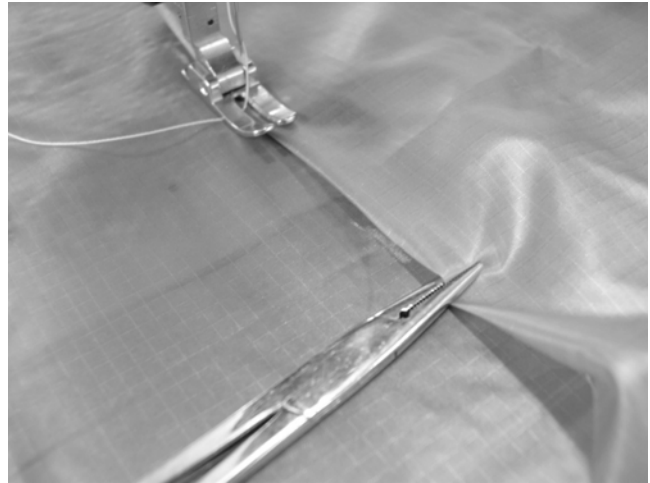

Disengage the puller if one exists on the sewing machine. This gives the person sewing more control over the fabric to prevent slippage and bunching.

Lower the foot and needle into the fabric. While using one hand to hold the two pieces of fabric taut in front, use your other hand to help feed the fabric thru the machine.



Sew to approximately 2 inches from the corner. Fold the 4-block seam allowance under for the second side creating a corner. Hold with the hemostats.



Make sure to set the hook in the stitch loop before lifting the foot to turn a corner. Sew to 1 block from the edge and turn the corner.



Sew the second side to 2 inches from the corner. Fold the 4-block seam allowance under for the third side creating a corner. Hold with the hemostats.

At this point make sure that the third and fourth sides will align properly before sewing.

Sew the third side, then the fourth side as shown.



Perform a 4-6 inch oversew.



Using scissors cut the damage out along the ripstop lines 7 boxes in from the stitching holding the patch on. Placing the hand between the patch and parachute while trimming (like wearing a mitten) will prevent damaging the patch with the scissors.



Make a diagonal cut in each corner to 3 ripstop boxes from the corner.

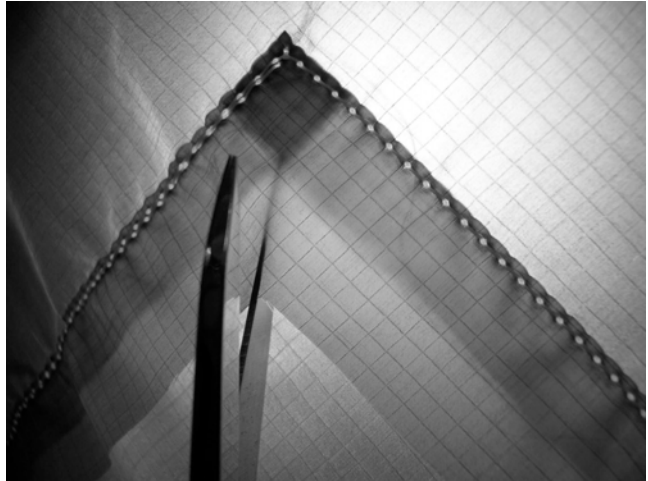

Place the work under the sewing machine. Using the hemostats clamp 1 ripstop box in from the cut edge.



Place the parachute fabric behind the fold back of the patch forming a French fell seam. Do this in two places and seat the 1 box fold back against the patch stitch row with the tip of the hemostat. Sew around the parachute patch repeating this process on each side.



Take care that each corner is fully seated and square.

Use the side of the presser foot as a guide for stitching.



Inspect the work thoroughly.

(PAGE INTENTIONALLY LEFT BLANK)

LINE REPLACEMENT

LINE REPLACEMENT

OVERVIEW

Damaged suspension lines shall not be repaired. A Master Rigger or his equivalent should replace the lines. Also, lines shall be replaced in pairs to minimize any asymmetrical line trim issues that may result from a single line replacement. Any line, tape, or webbing damage is classified as a major repair and therefore can only be performed by a Master Rigger or his equivalent.

REQUIRED EQUIPMENT AND MATERIALS

- Replacement lines from manufacturer
- V-T-295 size E nylon thread of the same color as used on the rest of the lines
- Bar tack or zig-zag machine
- Scissors
- Seam ripper
- Finger trapping needle

COMPLETE STEERING LINE REPLACEMENT

PROCEDURE

1. Remove the damaged steering line.
2. Starting with the outboard side, attach the new line to the parachute using the same knot as used on the other lines.
3. Bartack the fingertrap. Ensure the bartack originates at the fingertrap entry and extends toward the live side of the fingertrap.
4. Repeat steps 1 through 3 to attach all upper steering lines to the parachute.
5. Thread the lower steering line through the slider and steering line guide ring on the riser and tie to the steering toggle or loop.
6. Apply even tension and adjust all knots. Recheck all measurements.
7. Inspect the work thoroughly. Double check line lengths.
8. Perform a line continuity check.



LOWER STEERING LINE (LST) REPLACEMENT

PROCEDURE

1. Remove the damaged lower steering line.
2. Place the new lower steering line through the lower loops of the upper steering lines.
3. Fingertrap the line back into itself, ensuring the marks on the line match up.
4. Bartack the fingertrap ensuring it originates at the fingertrap entry and extends toward the live side of the fingertrap.
5. Attach bottom end of the lower steering line to the rapide link in the same location as the damaged lower line.
6. Perform a continuity check.

SUSPENSION LINE REPLACEMENT

The line being replaced will either be an A/B line or a C/D line. These lines come from the factory as follows:

- The "A" portion of the A/B line and the "C" portion of the C/D line will have a prefabricated loop for parachute attachment. (see picture)
- The "B" portion of the A/B line and the "D" portion of the C/D line come straight line (without a loop) and cut at an angle for finger trapping.

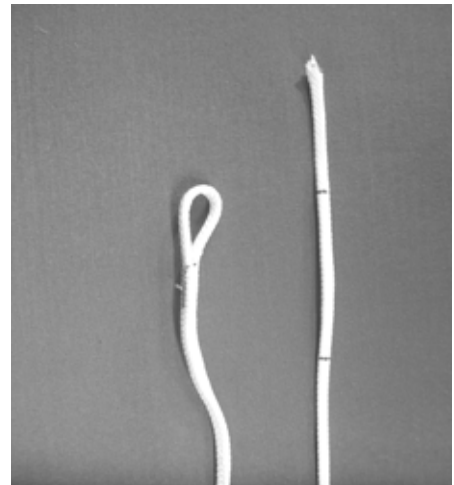

PROCEDURE

1. Remove the damaged line.
2. Attach either the A or the C line (depending on which line is being replaced) to the parachute using a lark's head knot.
3. Attach either the B or the D line (depending on which line is being replaced) to the parachute by wrapping the line around the parachute attachment loop to resemble a lark's head knot.
4. Verify the finger-trap match marks are aligned. This ensures the line is at its proper length.
5. Fingertrap the line back into itself, ensuring the marks on the line match up.
6. Bartack the fingertrap. Ensuring it originates at the fingertrap entry and extends toward the live side of the fingertrap.
7. Perform a line continuity check.
8. Repeat steps 1 through 7 for the line opposite the damaged line to ensure symmetry and trim.

(PAGE INTENTIONALLY LEFT BLANK)

SECTION 3:
PACKING INFORMATION

REPACK CYCLE

Currently, up to one-year repack cycles are authorized for Performance Designs reserve canopies when cared for properly. Proper care includes keeping the entire system clean, dry, limited exposure to UV light, not overheating, and no exposure to degrading elements. Performance Designs reserves the right to extend or reduce repack intervals based on continued research and field experience. You must use the shortest repack cycle applicable from the following: your country's applicable legal requirements, harness/container manufacturer's requirements, and AAD manufacturer's requirements. Your new Performance Designs reserve parachute must be assembled inspected and packed into your parachute system by a certificated rigger. Even if you live in a country where it is legal for you to assemble and maintain your reserve, you should let an experienced and appropriately rated person that is familiar with this reserve, your harness/container and all other components of the parachute system perform the assembly and repack.



**PACKING INSTRUCTIONS FOR HR-400-R1
HEAVY RESERVE PARACHUTE**

PACKING INSTRUCTIONS FOR HR-400-R1 RESERVE

OVERVIEW

If the rig manufacturer specifies a packing method other than the ones shown, and the rig manufacturer authorizes its use for this specific parachute, you may decide which instructions to follow. Otherwise you must follow the Performance Designs instructions. It is recommended that you follow the instructions for the packing method with which you are most familiar.

Inspect the parachute thoroughly before starting to pack it, following the inspection instructions described in Maintenance and Repair Section of this manual. Check the line continuity, and ensure the parachute has been assembled on the rig correctly.

Part 1A contains instructions for folding the parachute in a flat pack (or side pack) method.

Part 1B contains instructions for folding the parachute in a PRO pack method.

Part 2 contains a description of the reserve deployment bag along with instructions on how to insert the parachute into the bag.

Perform either 1A **OR** 1B. Then proceed to Part 2 to complete the reserve packing.

PART 1A:

SIDE PACK (OR FLAT PACK) INSTRUCTIONS – FOLDING

Flake out the parachute until all T-seams (where non-loaded ribs meet the top skin) are straight from leading edge to trailing edge.



Split the nose leaving 4 cells on either side with the center cell exposed.



Make sure the nose tapes are aligned.



Fold the outer 4 cells into alignment with the A-line extension.

Fold each set of 4 cells in towards the A line extension leaving the center cell exposed.



Make another fold on both sides until they meet in the center as shown.



While maintaining tension on the B line path...



...bring the A lines underneath the B lines.



Photograph shows the flaked parachute with A lines underneath the B lines.



Keeping tension on the B line path, grasp the fabric directly over the C line path.



Bring the C lines all the way past the B lines (photo)...

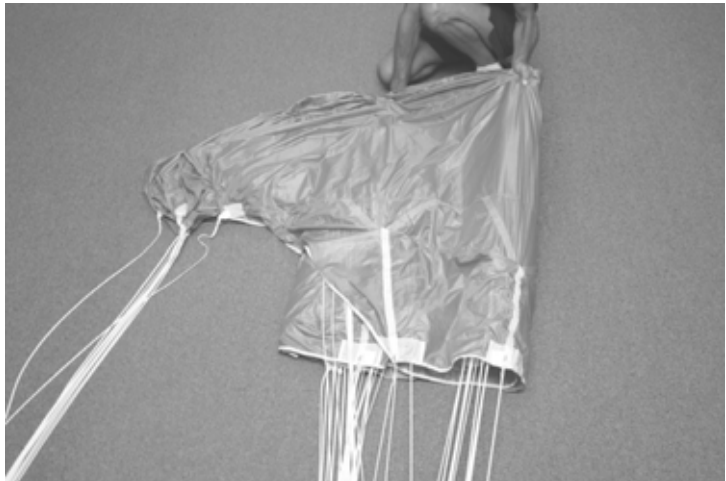

...then back, laying the C lines on top of the B line path.

This results in the parachute fabric between the B and C lines being folded on the left side of the parachute (as viewed by the rigger) and the C lines are directly on top of the B lines. Straighten this fold as necessary.



Keeping tension on the C line path, grasp the fabric directly over the D line path...



and place on top of the C line path.



Grasp the steering lines and place them on top of the D line path as shown.



Set the deployment brakes according to the harness and container manufacturer's instructions.



Clear the stabilizers...



...and flake the tail. Photo shows right side flaked.

While flaking the tail, note that the control lines are of different lengths. Therefore the tail seam is not evenly stacked, but positioned in such a way that all control lines are evenly tensioned.



Take the other half of the tail and fold it over.



Photo shows tail flaked.

Verify the stabilizers are still clear. Note that the lines attached to the stabilizers remain in the center along with the other lines.



Pull up the slider by grabbing the tapes around its center and walking from the connector links to the base of the folded parachute



Quarter the slider. This is accomplished by pulling the material between the front and rear slider grommets toward the outside of the pack job, into the fold formed by the stabilizers. Repeat for the opposite side.

Continue quartering by pulling the slider material between the two rear slider grommets toward the outside of the pack job. Do the same for the material between the front slider grommets.



Make sure the slider grommets are flush against the slider stops.



Grasp the tail at each edge of the center cell and pull down until even with the lower edge of the folded parachute. Raise the center cell of the tail approximately 6 inches and inspect the D lines and steering lines. Make sure all lines are taut.



Being careful not to disturb the flaking, wrap the tail underneath the entire pack job. Keep the tail tight around the grommets. This continues to reduce the width of the pack job.



PART 1B:

PRO PACK INSTRUCTIONS- FOLDING

Set the brakes according to container manufacturers instructions.

While standing between the risers, slip the fingers of your left hand between each left-hand riser and between the left-hand steering line and the risers. Do the same with your right hand. The idea is to have each line group and each steering line occupying a slot between two fingers.



Walk the lines up to the parachute keeping the slider in front of you.

The nose openings should be facing the rig.

Shake the parachute back and forth to allow the lines and fabric to settle.



Bring both sets of lines to one shoulder as shown.



Find the nose. Count each nose cell while aligning the tapes.

Put the nose between your legs to hold it in place for flaking.



Reach inside the stabilizers between the A and B lines. Clear the material by pushing it with the side of your hand towards the outside of the pack job.

Continue to do this between each line group and repeat for the opposite side.



Ensure no lines or fabric cross over the middle section.

Then bring up the tail and hold it.



Lift the parachute up as shown so you can see the nose. Flake the nose out leaving the center cell in the center, with four cells on either side of the center. This effectively splits the nose. Make sure the split is even.



Supporting the parachute, gently lay the parachute on the floor while continuing to hold the tail. This keeps the fabric from spreading out and disturbing the pack job.

The nose of the parachute is facing the floor.

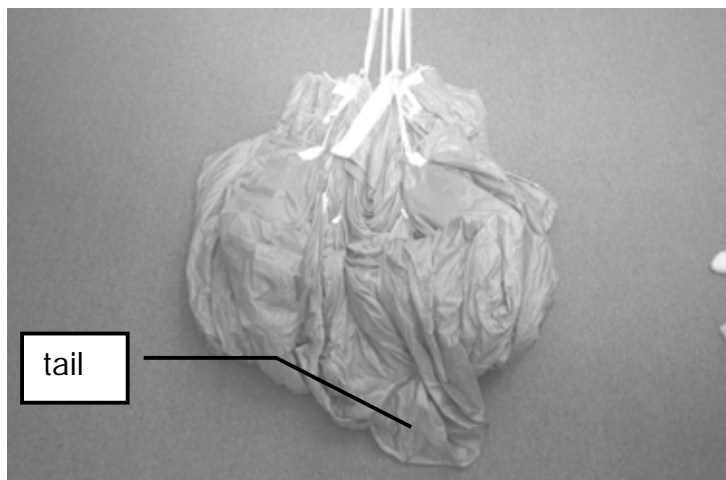

The tail should remain up to expose the line channel.

Using one arm and while keeping tension on the lines, gather half of the parachute...



... and roll it over to the side as shown.



Count out 4 nose cell seams and lay them on their side. The tapes should be neat, orderly and in alignment.

Ensure the nose is evenly flaked.



Hold the parachute down at the top seams following the A line path (as shown with the left hand in photo)

Pick up the 4 top seams mid-way between the A and B line path...



...and fold the fabric over the 4 nose cells.
This is the AB fold.



Pick up the 4 top seams mid-way between the B and C line path (as shown) and lay them down on the AB fold.



Pick up the 4 top seams mid-way between the C and D line path and lay them down on the BC fold as shown. This is the CD fold.



Next, fold the fabric between the D lines and the steering lines. This fold should be created on top of the CD fold fabric.

As you are doing this, place each control line on top of the previous line path (as shown). Control lines should be centered and in alignment with the existing line path.

Flake the tail on the side of the parachute that you've been working on.



The right side of the parachute (as viewed by you) is flaked.

Now repeat that process for the other side by doing the following:

Using one arm and while keeping tension on the lines, gather the other half of the parachute...

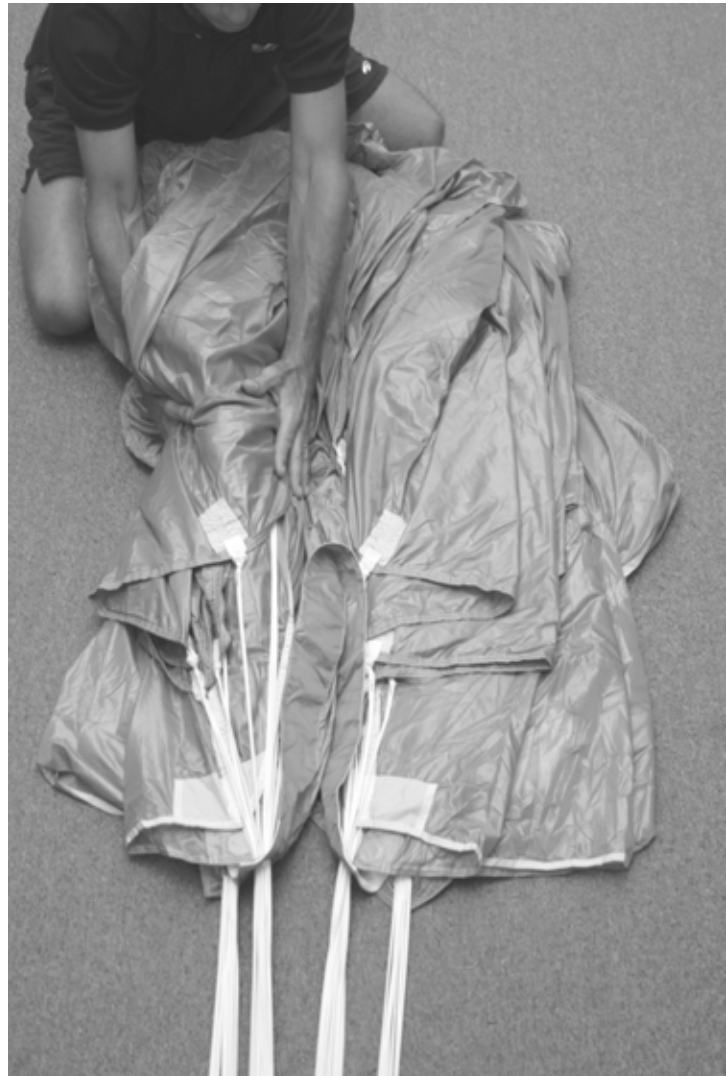

... and roll it over to the side as shown.



Count out 4 nose cell seams and lay them on their side as you did on the other side of the pack job. The tapes should be neat, orderly and in alignment. Ensure the nose is evenly flaked.

Create the AB fold in the same manner as you did for the other side of the pack job. Remember to maintain tension on the lines.

Create the BC fold in the same manner as you did for the other side of the pack job.



Create the next fold with the fabric between the C and D lines.



Next, fold the fabric between the D lines and the control lines. This fold should be created on top of the CD fold fabric.

As you are doing this, place each control line on top of the previous line path (as shown). Control lines should be centered and in alignment with the existing line path.

Flake the tail on the side of the parachute that you've been working on.



Photo shows the parachute properly flaked with the tail fabric at the top of the pack job. Notice how all the stabilizer fabric has been removed from the line area and is folded towards the outside of the pack job.



Quarter the slider. This is accomplished by pulling the material between the front and rear slider grommets toward the outside of the pack job, into the fold formed by the stabilizers. Repeat for the opposite side. Then continue by pulling the slider material between the two rear slider grommets toward the outside of the pack job. Do the same for the material between the front slider grommets.

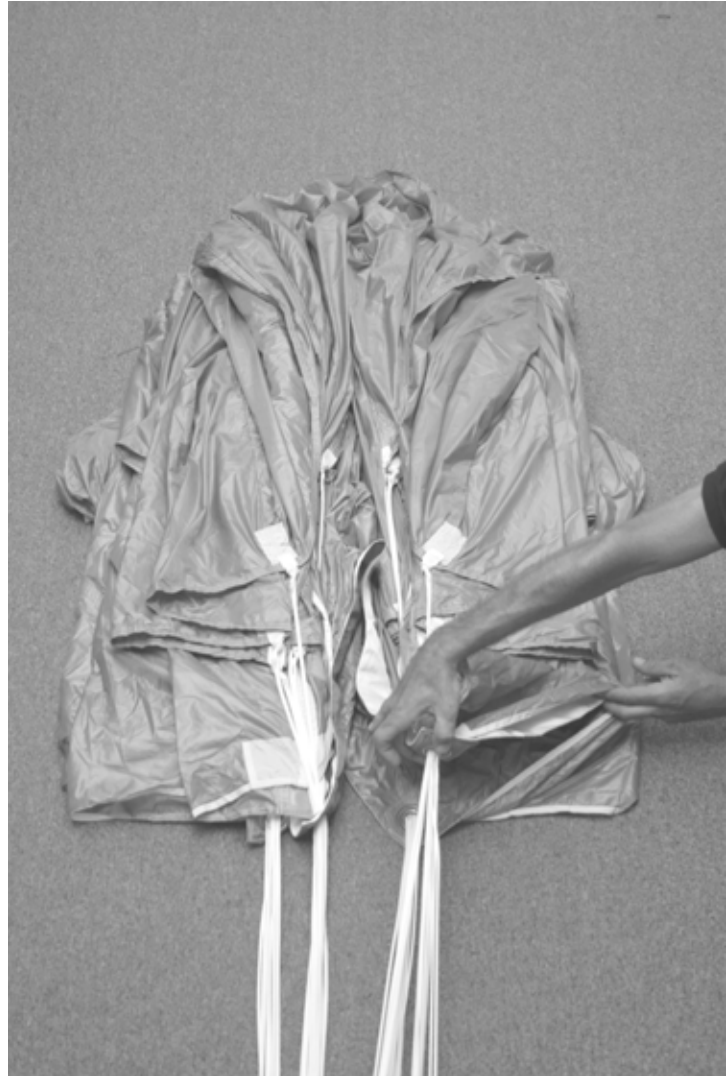

Flake the tail as shown.



(Reduction folds are folds in the fabric that decrease the width of the pack job.)

In preparation for the reduction fold, take half of the neatly folded parachute (not including the nose) and fold it in half as shown. This will expose half the nose.



Fold the nose in half underneath itself.



Nose shown folded in half.



Gently lift up on the parachute and fold the nose under once more towards the center of the parachute.



Taking the next fold, which is the AB fold, lay it down as shown.



Fold this AB fabric in half on top of itself for the reduction fold.



Completed reduction fold for the AB fabric shown.



Fold the CD fabric in half on top of itself for the reduction fold as shown.



Take the flaked tail and fold it back onto the reduction folds.



Repeat reduction folds for the other side.
Take the flaked tail and fold it back onto the reduction folds as shown.



Pull the tail down to cover the grommets keeping it about the width of the pack job.



Being careful not to disturb the flaking, wrap the tail underneath the entire pack job. Keep the tail tight around the grommets. This continues to reduce the width of the pack job.



PART 2:

THE DEPLOYMENT BAG:

COMPONENT IDENTIFICATION AND PREPARATION

The deployment bag should be oriented such that the safety stows are up and the line pouch is towards the packing surface/floor (as shown).



Flap #1 is shown folded back and contains the safety stow bands.

Flaps #2 and #3 are the side flaps and are closed in that order. Each flap contains two grommets.

Flap #4 is the last flap to be closed. It contains 4 grommets.

Closing order: flap 1, 2, 3, and then 4.

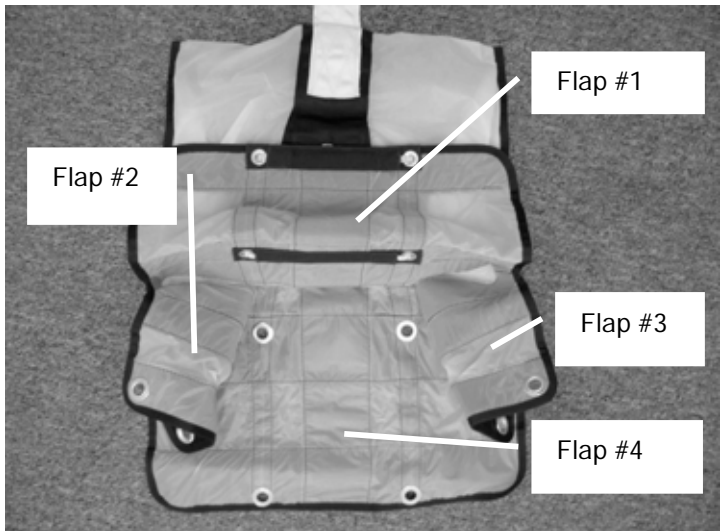

Safety stows: each set of safety stows is actually a single bungee running through a channel, creating two safety stows.

The band closest to the edge of the flap is the outer safety stow. The band closest to the inner portion of the bag is the inner safety stow.

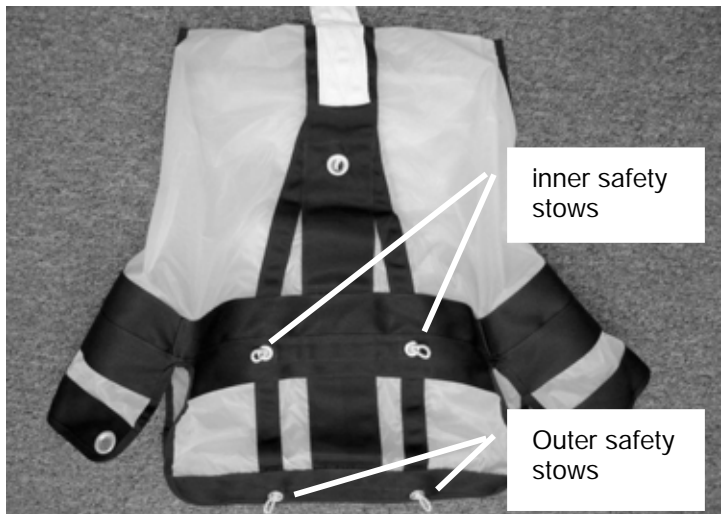

Insert a locking pull up cord through both center grommets on the bag. Secure the cord on the pouch (bottom) side of the bag and cinch down on the friction lock to the desired internal bag thickness.

Locking mechanisms vary with individual riggers, so yours may be different from the one shown.

The reason for this is to control the thickness of the pack job in order for it to be most efficiently inserted into the container.



The photo shows the locking pull-up cord going through the center of the reserve deployment bag.

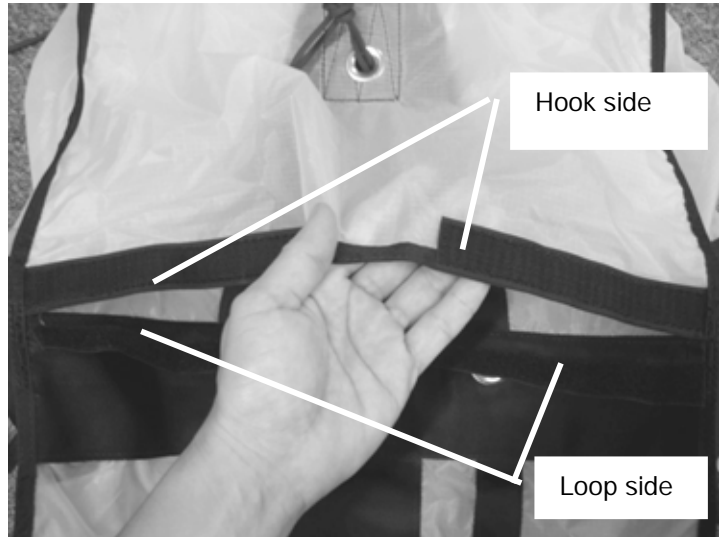

Photo shows a half-knot on the pouch side of the bag. This will be used to pull the reserve closing loop up through the bag. This side will be facing the packing surface/floor during packing.

Means of securing the loop may vary with individual riggers, so yours may be different from the one shown.



Before inserting the lines into the bag, the "hook" side of the hook and loop fastener should be covered in order to prevent snagging the suspension lines as they are inserted into the pouch. To prevent snagging, mate an approximately 6-inch strip of the "loop" portion to the "hook" portion (located on the pouch of the bag as shown).



BAG INSERTION INSTRUCTIONS

The width of the cocooned parachute should be about the same as the freebag.



Fold the bottom of the reserve back and on top of itself making an approximate 6-inch S-fold as shown.



Grasp both sides of the tail with one hand keeping control of it and bring it towards you creating another S fold.



Complete the S-fold as shown.



Carefully split the parachute so you have two ears (molar shape).



Fold one of the ears in half underneath itself (as shown).



Push the tongue of the bag as far underneath the parachute as possible as you are simultaneously inserting the folded ear into the bag.

tip: ensure center grommets are close to the 'dent' made in the middle.



Make sure to fill the corner of the bag with the inserted ear.



Repeat for the other side keeping the center grommets near the center of the dent/parachute center.(photo)

tip: pull the bag around the parachute instead of shoving the parachute into the bag.



The parachute is now in the freebag as shown.



Fold flap #1 over the parachute. The locking stows at the edge of flap #1 align with the grommets on flap #4 which are closest to the parachute.

Note: each set of two locking stows (left to right as shown) is actually a single bungee running through a channel. So pulling the upper right locking stow will cause the upper left stow to disappear inside the channel.



Note: The bridle goes underneath the lines and is the temporary lock for the side flaps. While holding onto one end of the locking stow, thread the other end of the locking stow through the flap #2 lower grommet, locking it in place with the bridle.

Secure flap #3 in the same manner so both stows are through the side flaps and are locked with the bridle (as shown).



Remove the bridle from the locking stow inserted through flap #2. Thread this locking stow through the #4 flap grommets. Now the bungee is routed first through flap #2 bottom grommets, then the top flap bottom grommets on each side.



Freebag is shown standing on its end.



Continuing to use the bridle as a temporary pin, secure the top two safety stows as shown.

Flaps #1, #2, and #3 are all closed and secured.



Remove the bridle from one locking stow and insert the locking stow through the associated grommet on flap #4. Repeat for the other side (as shown).



While keeping slight tension on the line, remove the bridle used as a temporary pin and make the first line stow as shown. The line bight should be approximately 3 _ inches.



Repeat for the second locking stow.



Stand the bag upright for ease of line stowage.

Remove the bridle and create the third line stow as shown. Make sure when you remove the bridle that you do not release the locking stow. Otherwise it will disappear inside the channel.



Remove the bridle and create the fourth line stow.



S-fold the suspension lines into the freebag pouch as shown.



Line should be stowed as shown.

Refer to container manufacturer instructions to insert bag into container.

NOTE: Remove the loop strips that were mated to the hook portion during the deployment bag preparation and close the mouth of the pouch.

The pull up cord will be used later to pull the closing loop through the center grommets of the bag during the closing of the container. It must be removed after that operation."

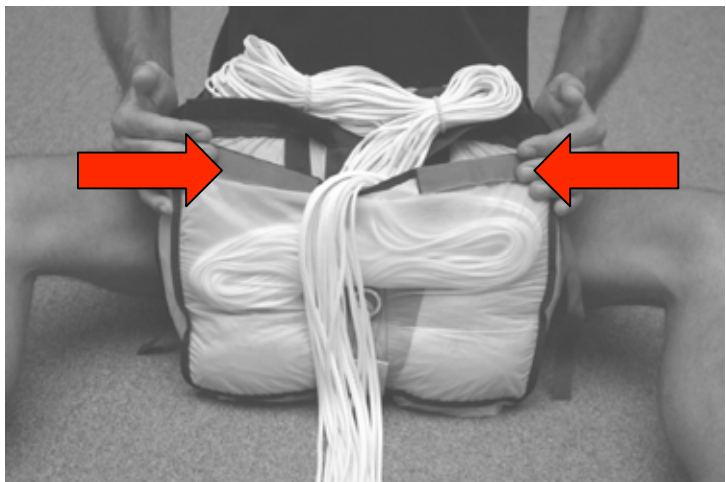

(PAGE INTENTIONALLY LEFT BLANK)

SECTION 4:
DRAWINGS

HR-400-R1 WARNING LABEL

WARNING															
THIS IS A HIGH PERFORMANCE PARACHUTE. EVEN NORMAL USE MAY RESULT IN SERIOUS INJURY OR DEATH. TRAINING, PROFICIENCY AND SKILL ARE REQUIRED TO LOWER THE RISK. READ AND COMPLY WITH ALL MANUFACTURER'S MANUALS, RECOMMENDATIONS, PROCEDURES, PLACARDS AND LIMITATIONS.															
PARACHUTE SYSTEMS SOMETIMES FAIL TO OPERATE CORRECTLY, EVEN WHEN PROPERLY MANUFACTURED, ASSEMBLED, PACKED AND OPERATED. YOU RISK SERIOUS INJURY AND DEATH EACH TIME YOU USE THIS SYSTEM.															
TRAINING AND PROFICIENCY REQUIREMENTS:															
DO NOT USE THIS PARACHUTE SYSTEM UNLESS YOU HAVE:															
A. RECEIVED INSTRUCTION IN THE USE OF THIS SPECIFIC PARACHUTE SYSTEM AND OPERATE IT WITHIN THE STUDENT OR NOVICE LIMITATIONS LISTED BELOW:															
-OR-															
B. PERFORMED AT LEAST 50 RAM AIR PARACHUTE JUMPS AND AT LEAST 10 SOFT STAND UP LANDINGS, WITHIN THE TARGET AREA, USING A CANOPY NO MORE THAN 15% LARGER THAN THIS SIZE.															
-OR-															
C. EXPERIENCE WITH THIS EQUIPMENT AND ARE HIGHLY FAMILIAR AND PROFICIENT WITH THE OPERATION, FLIGHT AND LANDING CHARACTERISTICS OF THIS MODEL/SIZE PARACHUTE AND SYSTEM															
SKILL AND OPERATING LIMITS (STD. DAY TEMP. AT SEA LEVEL):															
WEIGHTS LISTED ARE (jumper + clothing + equipment) LBS (KG)															
<table border="1" style="width: 100%; border-collapse: collapse;"> <tr> <th style="width: 10%;">MIN. WT.</th> <th style="width: 10%;">STUDENT*</th> <th style="width: 10%;">NOVICE*</th> <th style="width: 10%;">INT.*</th> <th style="width: 10%;">ADV.*</th> <th style="width: 10%;">EXPERT*</th> <th style="width: 10%;">MAX. WT.</th> </tr> <tr> <td>200 (91)</td> <td>350 (159)</td> <td>350 (159)</td> <td>350 (159)</td> <td>400 (181)</td> <td>550 (250)</td> <td>550 (250)</td> </tr> </table>		MIN. WT.	STUDENT*	NOVICE*	INT.*	ADV.*	EXPERT*	MAX. WT.	200 (91)	350 (159)	350 (159)	350 (159)	400 (181)	550 (250)	550 (250)
MIN. WT.	STUDENT*	NOVICE*	INT.*	ADV.*	EXPERT*	MAX. WT.									
200 (91)	350 (159)	350 (159)	350 (159)	400 (181)	550 (250)	550 (250)									
MAXIMUM DEPLOYMENT SPEED 180 KTS EAS @ SEA LEVEL															
* MAXIMUM WEIGHT, TO REDUCE RISKS STAY WELL BELOW THIS WEIGHT.															
-WEIGHT ADJUSTMENTS FOR LANDING CONDITIONS: REDUCE ALL WEIGHTS BY 2% PER 1000 FT (300M) LANDING ELEVATION. REDUCE ALL WEIGHTS BY AN ADDITIONAL 1% FOR EVERY 3° C (5° F) ABOVE STD. DAY TEMP., WHICH IS 15°C (59°F) AT SEA LEVEL. STD DAY TEMP. DECREASES 2°C (3.5°F) PER 1000 FT (300M) FOR EACH 1000 FT ABOVE SEA LEVEL.															
-OPENING FORCES INCREASE WITH ALTITUDE, REDUCE MAXIMUM WEIGHT AND/OR MAXIMUM AIRSPEED (EAS) FOR DEPLOYMENT ALTITUDE.															
**VARIES WITH WEATHER/LANDING CONDITIONS															
-APPROVED FOR TANDEM USE MAXIMUM DEPLOYMENT WEIGHT															
DATE OF MANUFACTURE DATE	INSP:														
PN: HR400??															
REMOVAL OF THIS LABEL VOIDS ALL WARRANTIES															
CANOPY HISTORY LOG															
EACH TIME THIS CANOPY IS PACKED BUT HAS NOT BEEN JUMPED, MARK A DIAGONAL BAR IN THE NEXT EMPTY BOX <input type="checkbox"/>															
EACH TIME THIS CANOPY IS PACKED AFTER IT HAS BEEN JUMPED, MARK A "X" IN THE NEXT EMPTY BOX <input type="checkbox"/>															
THIS CANOPY MUST RECEIVE A FABRIC PERMEABILITY TEST WITHIN EACH 25 JUMPS AND 40 PACKS. DO NOT REPACK UNLESS THESE REQUIREMENTS ARE MET.															
<table border="1" style="width: 100%; border-collapse: collapse;"> <tr> <td style="width: 25%; height: 15px;"></td> <td style="width: 25%; height: 15px;"></td> <td style="width: 25%; height: 15px;"></td> <td style="width: 25%; height: 15px;"></td> </tr> </table>															
HR-400-TYPE	MODEL #														
HR400-CUT REVISION FROM PRODUCTION ORDER	PART #														
HR400-NUMBER FROM PRODUCTION ORDER	SERIAL #														
Performance Designs <small>1300 E. International Speedway Blvd. DeLand, Florida 32724</small>	HR-400 Warning Label Top Drawing	Date 22 Nov 2004	By R. D. R.												
	Document No # TDWG-002	Rev A	Sheet 4 of 5												



HR-400-R1 FLYING FRONT VIEW

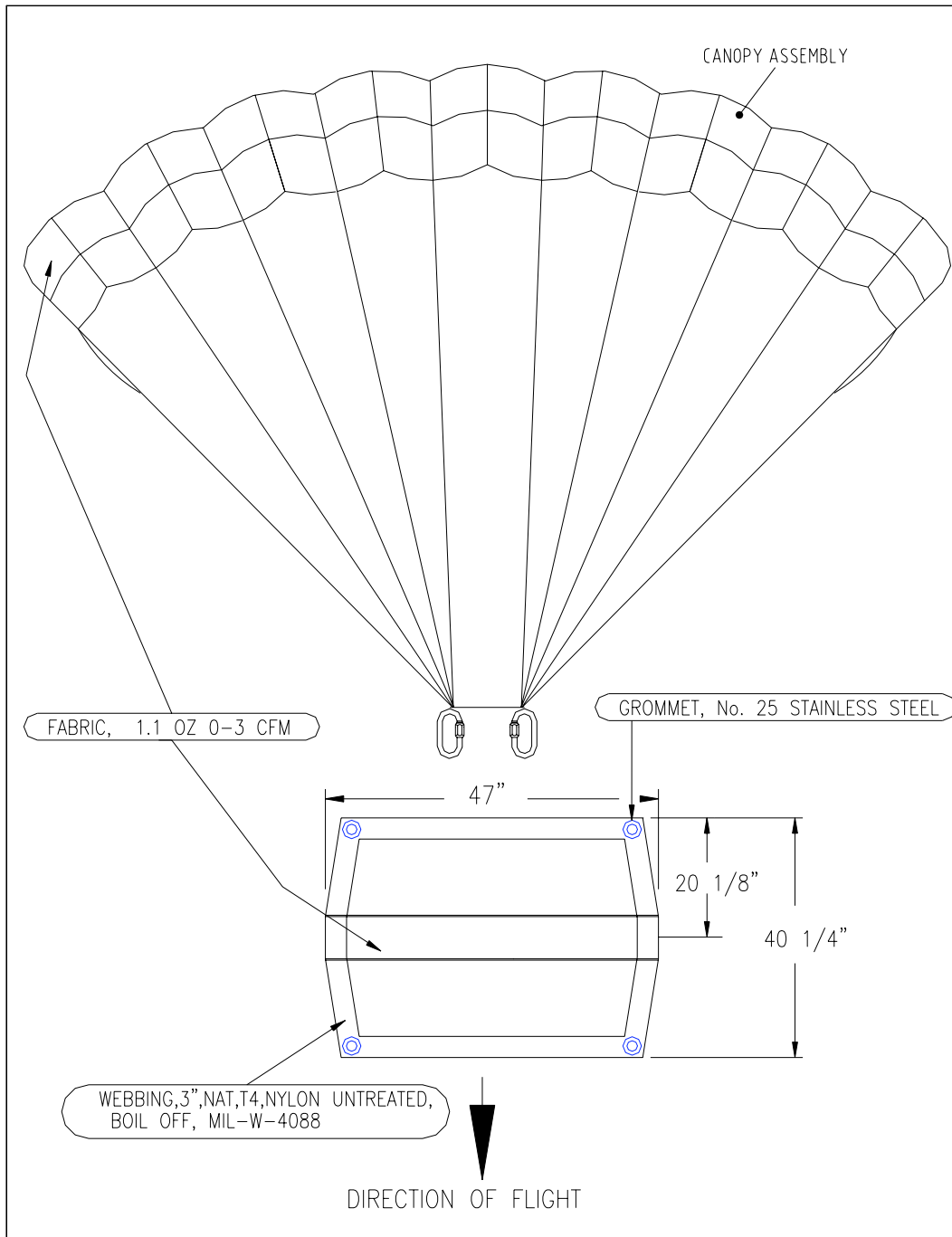

 Performance Designs <small>1300 E. International Speedway Blvd. DeLand, Florida 32724</small>	HR-400 Flying Front	Date 22 Nov 2004	By R. D. R.
	Top Drawing	Document No.# TDWG-002	Rev. Sheet A 2 of 5



HR-400-R1 FLYING SIDE VIEW

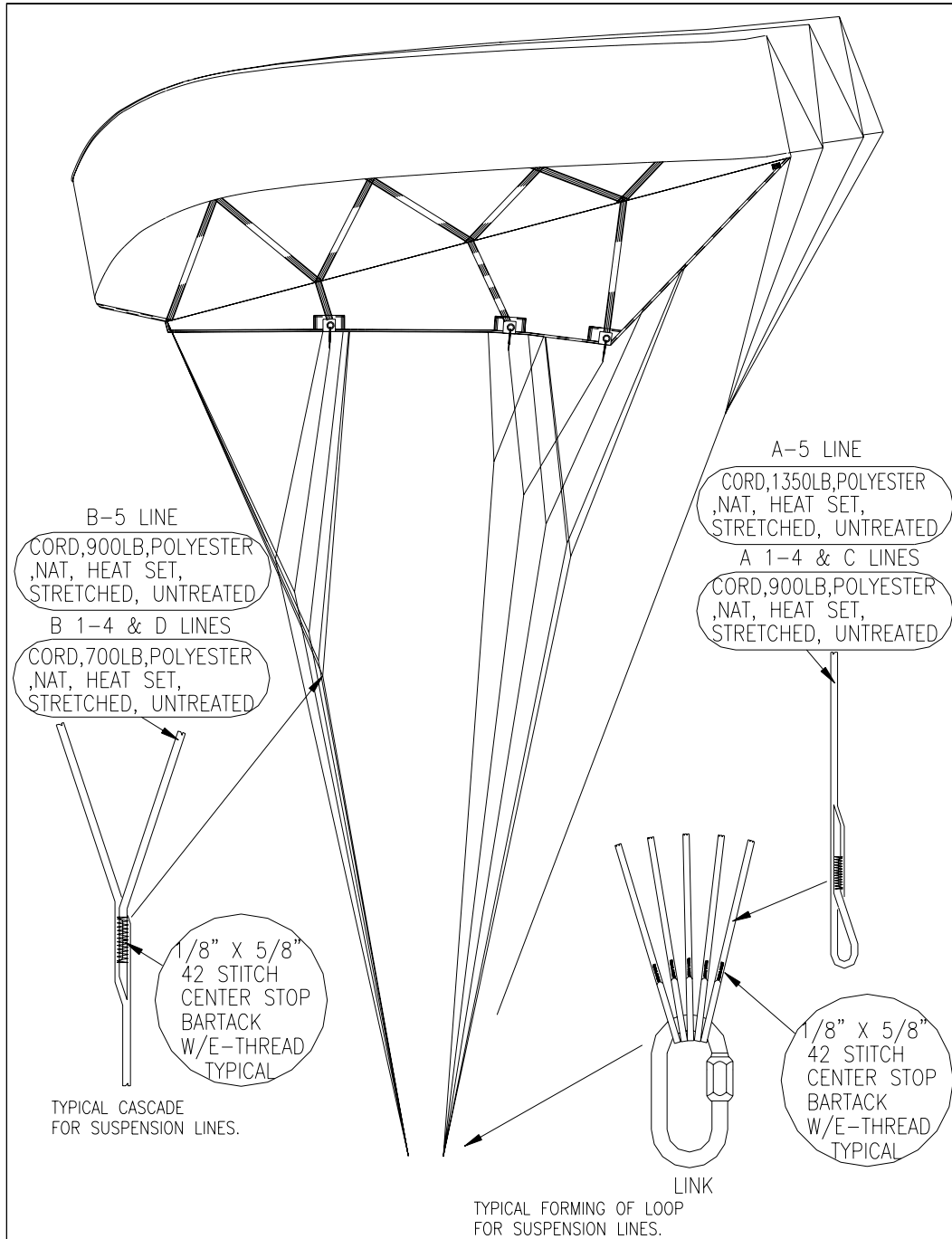

 <p>1300 E. International Speedway Blvd. DeLand, Florida 32724</p>	HR-400 Side View		Date 22 Nov 2004	By R. D. R.
	Top Drawing		Document No # TDWG-002	Rev. Sheet A 3 of 5



HR-400-R1 PLANFORM

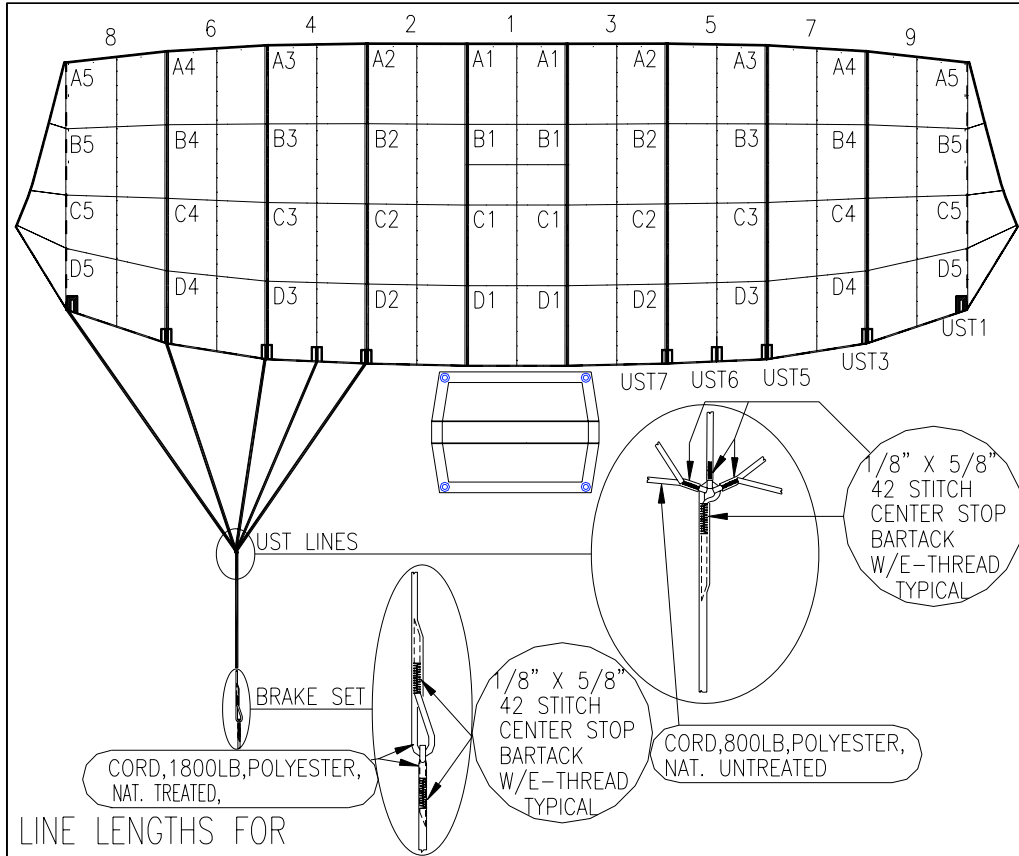

LINE LENGTHS FOR EQUIPMENT INSPECTION

A5 LINE	208 1/4"	± 1"	A5 TO B5	3"	± 1/2"
A4 LINE	207 7/8"	± 1"	A5 TO C5	10"	± 1/2"
A3 LINE	207 5/8"	± 1"	A5 TO D5	18 1/8"	± 1/2"
A2 LINE	207 1/4"	± 1"	A4 TO B4	2 7/8"	± 1/2"
A1 LINE	207 1/4"	± 1"	A4 TO C4	11 1/8"	± 1/2"
			A4 TO D4	22 3/4"	± 1/2"
SEAM TO SEAM TOP SKIN #1	41 1/4" TO 42 3/8"		A3 TO B3	3"	± 1/2"
B1 TO C1	34" TO 35 1/2"		A3 TO C3	12"	± 1/2"
BRAKE TO TOGGLE	31 1/4"		A3 TO D3	25"	± 1/2"
			A2 TO B2	3 1/4"	± 1/2"
A5 TO UST1	17 1/4"	± 1"	A2 TO C2	12 1/4"	± 1/2"
A5 TO UST3	7"	± 1"	A2 TO D2	25 3/4"	± 1/2"
A5 TO UST5	5 3/8"	± 1"	A1 TO B1	3 1/4"	± 1/2"
A5 TO UST6	7 1/8"	± 1"	A1 TO C1	12 1/2"	± 1/2"
A5 TO UST7	12 5/8"	± 1"	A1 TO D1	26"	± 1/2"



HR-400 Planform
Top Drawing

Date 22 Nov 2004
By R. D. R.
Document No.# TDWG-002
Rev. A
Sheet 1 of 5



HR-400-R1 DAMAGE CHART

Serial # _____ HEAVY RESERVE Tracking # _____

TE 502	LE 8E	TE	LE
208	B8	109	T9
206	B6	107	T7
204	B4	105	T5
202	B2	103	T3
201	B1	101	T1
203	B3	102	T2
205	B5	104	T4
207	B7	106	T6
209	B9	108	T8
501	9E		

Date # _____ DCH-008_REV.A 10F2 Insp # _____



HR-400-R1 DAMAGE CHART

