

ICON HARNESS/CONTAINER  
PACKING MANUAL  
&  
SKYHOOK ADDENDUM





## ICON HARNESS/CONTAINER PACKING MANUAL & SKYHOOK ADDENDUM

TM 162

REVISED January 10

### ICON HARNESS CONTAINER SIZES

	MAIN	RESERVE SIZE
I1	90-96 SQ.FT	99 SQ.FT
I2	96-111	99-110
I3	117-132	110-120
I4	132-150	135-150
I5	150-168	150-175
I6	168-190	175-190
I7	210-250	190-250
S7	210-250	190-250
S8	250-270	220-250
S9	250-290	220-250

PRIOR TO ASSEMBLY, PACKING OR USE OF THIS PRODUCT, READ AND FULLY UNDERSTAND THE CONTENT AND ALL WARNINGS CONTAINED IN THIS MANUAL, AND CAREFULLY FOLLOW ALL INSTRUCTIONS BEFORE AND DURING PACKING AND USING THE PARACHUTE SYSTEM

AERODYNE Research LLC 1405 Flight Line Blvd. Unit 20, Deland, FL 32724-2192  
TEL: (813)891-6300 FAX: (831)891-6315 [www.flyaerodyne.com](http://www.flyaerodyne.com)

## CONTENTS

<b>Letter from The Aerodyne Team</b>		<b>i</b>
<b>WARNING</b>		<b>ii</b>
<b>DISCLAIMER; LIMITATION OF WARRANTY ON PARACHUTE; LIMITATION OF REMEDIES; WAIVER AND RELEASE OF WARRANTIES</b>		<b>iii</b>
<b>1. TECHNICAL SPECIFICATIONS</b>		<b>1</b>
<b>1.1</b> INTRODUCTION		1
<b>1.2</b> DESCRIPTION		1
<b>1.3</b> MARKING & COMPONENTS LIST		2
1.3.1 FRONT LEFT RESERVE RISER LABEL		
1.3.2 DATA CARD POCKET LABEL		
1.3.3 WARNING LABEL		
<b>1.4</b> TECHNICAL SPECIFICATIONS AND LIMITATIONS		3
<b>1.5</b> MAJOR COMPONENTS AND ACCESSORIES		4
<b>2. OPERATING INSTRUCTIONS</b>		<b>5</b>
<b>2.1</b> INSPECTION BEFORE PACKING AND ASSEMBLY		5
<b>2.2</b> SOFT LINKS ASSEMBLY		6
<b>2.3</b> AAD INSTALLATION PROCEDURE		7
2.3.1 CYPRES INSTALLATION		
2.3.2 FXC INSTALLATION		
<b>2.4</b> RESERVE ASSEMBLY		11
2.4.1 CONNECTING THE CANOPY TO THE CONTAINER		
2.4.2 RESERVE TOGGLE ASSEMBLY		
2.4.3 RESERVE CLOSURE LOOP ASSEMBLY		
2.4.4 PACKING THE RESERVE CANOPY		
2.4.5 STOWING THE RESERVE LINES		
2.4.6 PACKING THE RESERVE CONTAINER (NON-SKYHOOK ONLY)		
2.4.7 RSL INSTALLATION (NON-SKYHOOK ONLY)		
<b>2.5</b> MAIN ASSEMBLY		20
2.5.1 SOFT LINKS ASSEMBLY		
2.5.2 MAIN TOGGLE ASSEMBLY		
2.5.3 MINIFORCE™ THREE RING RISER INSTALLATION		
2.5.4 MAIN DEPLOYMENT & D-BAG ASSEMBLY		
2.5.5 PACKING THE MAIN CONTAINER		
2.5.6 FOLDING THE PILOT CHUTE		
<b>3. MAINTENANCE &amp; REPAIRS</b>		<b>31</b>
<b>3.1</b> INSPECTION FREQUENCY		31
<b>3.2</b> MAINTENANCE FREQUENCY		31

PRIOR TO ASSEMBLY, PACKING OR USE OF THIS PRODUCT, READ AND FULLY UNDERSTAND THE CONTENT AND ALL WARNINGS CONTAINED IN THIS MANUAL, AND CAREFULLY FOLLOW ALL INSTRUCTIONS BEFORE AND DURING PACKING AND USING THE PARACHUTE SYSTEM

<b>3.3</b>	STORAGE	33
<b>3.4</b>	USER CHECK-LIST BEFORE JUMP	33
<b>4.</b>	SKYHOOK ADDENDUM	34
<b>5.</b>	MAINTENACE LOG	38

PRIOR TO ASSEMBLY, PACKING OR USE OF THIS PRODUCT, READ AND FULLY UNDERSTAND THE CONTENT AND ALL WARNINGS CONTAINED IN THIS MANUAL, AND CAREFULLY FOLLOW ALL INSTRUCTIONS BEFORE AND DURING PACKING AND USING THE PARACHUTE SYSTEM

AERODYNE Research LLC 1405 Flight Line Blvd. Unit 20, Deland, FL 32724-2192  
TEL: (813)891-6300 FAX: (831)891-6315 [www.flyaerodyne.com](http://www.flyaerodyne.com)

What is Aerodyne all about? It's pretty simple really, something of a mantra for our company:

## *Better Gear, Better Value, Better Skydives*

*Better Gear* has always been part of Aerodyne's DNA. We began with the do-it-all 7 cell, the Triathlon. We created the Smart Reserve, known around the world for superior quality. We created the Pilot, arguably the best-opening performance canopy on the market. With the Mamba, we've taken non-cross-braced elliptical canopy design to new performance highs. We developed a better cutaway system with the mini-force ring; even our hook knife outclasses the competition by a mile. "Better" really drives everything we do; as we develop innovative fabrics like zpX, as we bring out canopies like the Sensei and more A2 sizes, as we continue to improve an already outstanding Icon rig, we are following this mantra.

The second part is about providing *Better Value*. This is not necessarily about the lowest price, but about providing great value for money. We know our customers work hard and play hard and expect to get real value for the money they spend. Better products at comparable prices mean better value. Better customer service, provided by people who really know the equipment is also part of Aerodyne's commitment to better value.

The final part is about *Better Skydives*. We are a company owned and staffed by skydivers. We get it! Skydiving is fun, and the better your jumps, the more fun you have. We support this by not only making the best gear and providing the best value we can, but by taking our product out there. You'll see us at the DZ almost every weekend, jumping, load organizing, and generally having fun. We ask that our sponsored teams and individuals do the same, putting their time and energy into improving your skydives and your fun. That's why you skydive, and we're here to help.

### *The Aerodyne Team*

# WARNING!

1. Proper training and/or experience are required to lower the risk of serious injury or death.

NEVER USE THIS EQUIPMENT UNLESS YOU HAVE:

- A. READ THIS WARNING LABEL, APPROPRIATE OWNERS MANUAL, PACKING INSTRUCTIONS AND COMPLETED A “CONTROLLED PROGRAM OF INSTRUCTION” IN THE USE OF THIS PARACHUTE SYSTEM.

OR

- B. READ THIS WARNING LABEL AND APPROPRIATE OWNERS MANUAL AND PACKING INSTRUCTIONS AND COMPLETED AT LEAST 100 RAM AIR PARACHUTE JUMPS.

2. LOWER THE RISK OF DEATH, SERIOUS INJURY, CANOPY DAMAGE AND HARD OPENINGS BY NEVER EXCEEDING THE MAXIMUM LIMITS:

- A. 136 Kg
- B. 150 Knots

HARD OPENINGS CAN CAUSE EQUIPMENT DAMAGE, SEVERE INJURY OR DEATH. PARACHUTE SYSTEMS SOMETIMES FAIL TO FUNCTION PROPERLY EVEN WHEN CORRECTLY ASSEMBLED, PACKED AND OPERATED. YOU RISK SERIOUS INJURY OR DEATH EACH TIME YOU USE THIS OR ANY PARACHUTE SYSTEM, BY DOING SO YOU WILL BE DEEMED TO HAVE EXPRESSLY AND IMPLIEDLY ASSUMED THIS RISK

**AERODYNE RESEARCH, LLC**  
**1405 Flight Line Blvd. Unit 20**  
**Deland, FL 32114**

PRIOR TO ASSEMBLY, PACKING OR USE OF THIS PRODUCT, READ AND FULLY UNDERSTAND THE CONTENT AND ALL WARNINGS CONTAINED IN THIS MANUAL, AND CAREFULLY FOLLOW ALL INSTRUCTIONS BEFORE AND DURING PACKING AND USING THE PARACHUTE SYSTEM

**DISCLAIMER; LIMITATION OF WARRANTY ON PARACHUTE; LIMITATION OF REMEDIES;  
WAIVER AND RELEASE OF WARRANTIES**

**BY ACCEPTING AND USING THIS PARACHUTE, OR BY ALLOWING OTHERS TO USE IT, YOU CONFIRM THAT YOU UNDERSTAND THAT BECAUSE OF THE UNAVOIDABLE DANGER ASSOCIATED WITH THE USE OF THIS PARACHUTE, THE MANUFACTURER MAKES NO WARRANTY WHATSOEVER, EXPRESS OR IMPLIED, ARISING BY LAW OR OTHERWISE, EXCEPT A WARRANTY THAT A PARACHUTE OF SIMILAR DESIGN HAS BEEN PREVIOUSLY USED FOR PARACHUTE JUMPING. THE PARACHUTE IS SOLD, CONVEYED, LOANED, GIFTED, OR OTHERWISE DELIVERED, FURNISHED OR PROVIDED TO YOU BY THE MANUFACTURER, OR ON ITS BEHALF, AS IS, WITH ALL FAULTS, AND WITHOUT ANY WARRANTY OF MERCHANTABILITY OR FITNESS FOR USE.**

**THE MANUFACTURER EXPRESSLY DISCLAIMS ANY LIABILITY UNDER THE LAW, IN TORT OR OTHERWISE, FOR DAMAGES, DIRECT OR CONSEQUENTIAL, INCLUDING BUT NOT LIMITED TO DAMAGES FOR PERSONAL INJURIES, WRONGFUL DEATH, PROPERTY DAMAGE AND LOSS OF USE OF THE PARACHUTE, RESULTING FROM ANY MALFUNCTION OF THE PARACHUTE, OR FROM ANY DEFECT IN DESIGN, MATERIAL, WORKMANSHIP OR MANUFACTURE OF THE PARACHUTE, WHETHER CAUSED BY NEGLIGENCE ON THE PART OF THE MANUFACTURER, AND/OR BY ANY AND ALL MANUFACTURERS OF ANY AND ALL PARTS, ACCESSORIES, COMPONENTS, OR APPLIANCES MADE A PART OF, OR APPURTENANT TO, THE PARACHUTE.**

**YOU, BY YOUR USE OF THE PARACHUTE, AND/OR BY ALLOWING IT TO BE USED BY OTHERS, SPECIFICALLY WAIVE ANY LIABILITY ON THE PART OF THE MANUFACTURER FOR PERSONAL INJURIES, WRONGFUL DEATH, LOSS OF CONSORTIUM, PROPERTY DAMAGE AND LOSS OF USE OF THE PARACHUTE. YOU AGREE, AND HAVE MATERIALLY REPRESENTED TO THE MANUFACTURER, THAT YOU ARE A "HIGHLY SOPHISTICATED AND EXPERIENCED CONSUMER" WITH RESPECT TO THE PARACHUTE, AND THAT YOU ARE THOROUGHLY AWARE OF, AND EXPRESSLY ACCEPT, ANY AND ALL OF THE RISKS OF PHYSICAL INJURY, DEATH AND/OR PROPERTY DAMAGE WHICH MAY OCCUR AS A RESULT OF YOUR USE AND/OR MISUSE OF THE PARACHUTE DESIGNED BY, MANUFACTURED BY AND/OR RECEIVED FROM THE MANUFACTURER. AS A "HIGHLY SOPHISTICATED AND EXPERIENCED CONSUMER," YOU EXPRESSLY WAIVE ANY CLAIM YOU MIGHT OTHERWISE HAVE OF STRICT LIABILITY AGAINST THE MANUFACTURER.**

**THE WARRANTIES SET FORTH ABOVE, AND THE OBLIGATIONS AND LIABILITIES OF THE MANUFACTURER, AND YOUR REMEDIES THEREUNDER, ARE EXPRESSLY IN LIEU OF, AND YOU HEREBY WAIVE AND RELEASE THE MANUFACTURER FROM, ANY AND ALL OTHER WARRANTIES, AGREEMENTS, GUARANTEES, CONDITIONS, DUTIES, OBLIGATIONS, REMEDIES OR LIABILITIES, EXPRESS OR IMPLIED, ARISING BY LAW OR OTHERWISE, INCLUDING, WITHOUT LIMITATION, ANY WARRANTY OF MERCHANTABILITY AND FITNESS FOR PARTICULAR PURPOSE, AND IMPLIED WARRANTIES, INCLUDING BUT NOT LIMITED TO THOSE**

**PRIOR TO ASSEMBLY, PACKING OR USE OF THIS PRODUCT, READ AND FULLY UNDERSTAND THE CONTENT AND ALL WARNINGS CONTAINED IN THIS MANUAL, AND CAREFULLY FOLLOW ALL INSTRUCTIONS BEFORE AND DURING PACKING AND USING THE PARACHUTE SYSTEM**

**ARISING FROM COURSE OF PERFORMANCE, DEALING, USAGE OR TRADE, WITH RESPECT TO THE MANUFACTURER'S PERFORMANCE HEREUNDER, AND YOU AGREE THAT THE MANUFACTURER SHALL NOT BE LIABLE FOR ANY DAMAGE OR LOSS (INCLUDING BUT NOT LIMITED TO CONSEQUENTIAL DAMAGES) SUFFERED BY YOU, DIRECTLY OR INDIRECTLY, BECAUSE OF ANY DEFECT IN THE PARACHUTE. NO AGREEMENT OR UNDERSTANDING VARYING, ALTERING OR EXTENDING THE MANUFACTURER'S LIABILITY HEREUNDER SHALL BE BINDING ON THE MANUFACTURER, UNLESS IN WRITING AND SIGNED BY A DULY AUTHORIZED REPRESENTATIVE OF THE MANUFACTURER, AND BY YOU OR YOUR DULY AUTHORIZED REPRESENTATIVE.**

**IF YOU DECLINE TO WAIVE LIABILITY ON THE PART OF THE MANUFACTURER, OR IF YOU DECLINE TO AGREE TO ALL OF THE TERMS OF THIS "DISCLAIMER – LIMITATION OF WARRANTY ON PARACHUTE; LIMITATION OF REMEDIES; WAIVER AND RELEASE OF WARRANTIES," YOU MAY OBTAIN A FULL REFUND OF THE PURCHASE PRICE BY RETURNING THE PARACHUTE, BEFORE IT IS USED, TO THE MANUFACTURER, WITHIN 15 DAYS FROM THE DATE OF YOUR RECEIPT OF THE PARACHUTE, WITH A LETTER STATING WHY IT WAS RETURNED.**

**PRIOR TO ASSEMBLY, PACKING OR USE OF THIS PRODUCT, READ AND FULLY UNDERSTAND THE CONTENT AND ALL WARNINGS CONTAINED IN THIS MANUAL, AND CAREFULLY FOLLOW ALL INSTRUCTIONS BEFORE AND DURING PACKING AND USING THE PARACHUTE SYSTEM**



# 1 TECHNICAL SPECIFICATIONS

## 1.1 INTRODUCTION

THE ICON HARNESS AND CONTAINER SYSTEM MUST BE CHECKED AND ASSEMBLED BY A QUALIFIED RIGGER.

Before assembly, check the harness, container and all components, ensuring that the Reserve and Main container sizes are compatible with the Reserve and Main canopies, and deployment systems with which it is to be used.

## 1.2 DESCRIPTION: Icon is an individual harness and container system

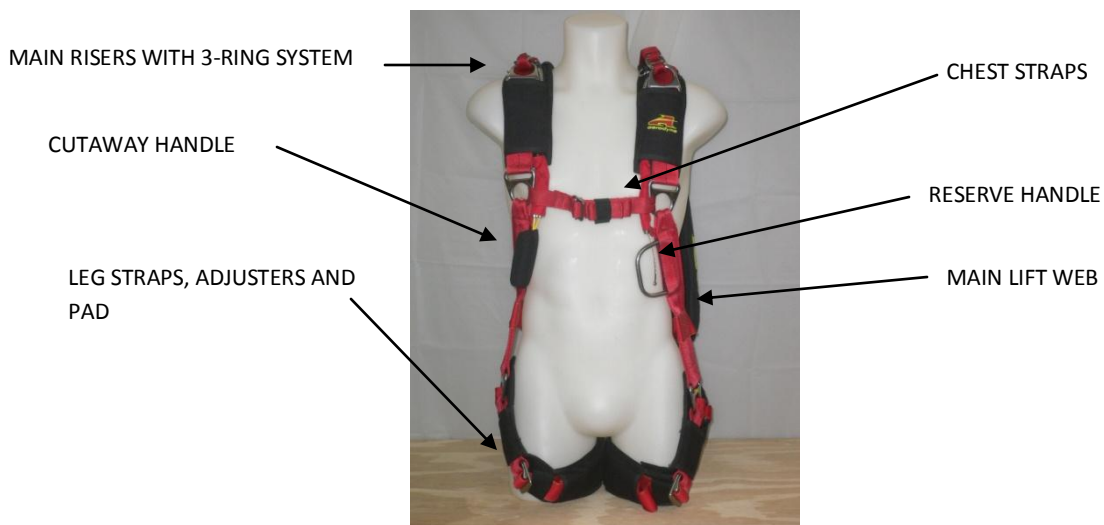

PRIOR TO ASSEMBLY, PACKING OR USE OF THIS PRODUCT, READ AND FULLY UNDERSTAND THE CONTENT AND ALL WARNINGS CONTAINED IN THIS MANUAL, AND CAREFULLY FOLLOW ALL INSTRUCTIONS BEFORE AND DURING PACKING AND USING THE PARACHUTE SYSTEM

### 1.3 MARKING & LIST OF COMPONENTS

Removal of any of the TSO labels or Warning labels VOIDS the TSO and warranty.

#### 1.3.1 TSO C23d ON LEFT RESERVE RISER

AERODYNE RESEARCH LLC 1405 FLIGHT LINE BLVD STE 20 DELAND, FL 32724 USA  
TSO C23d  
PART NO:                      HARNESS TYPE:                      D.O.M.:  
CONTAINER SIZE:              VERSION:                      SERIAL NO.  
HARNESS SIZE:  
MAX. OPERATING LIMITS: 136 Kg 150 KTS  
AVERAGE PEAK FORCE DURING 4.3.4 STRENGTH TESTS: 5.45 G's

#### 1.3.2 DATA CARD POCKET LABEL

AERODYNE RESEARCH LLC 1405 FLIGHT LINE BLVD STE 20 DELAND, FL 32724

MAX SPEED	KTS.	KTS
MAX WEIGHT	KG	KG

LIMITATIONS: Maximum Weight and Speed is the lower of the 2 values:  
136 KG/ 150 KTS or the Reserve Canopy TSO Maximum Limitations

#### 1.3.3 WARNING LABEL

**WARNING!** 1. PARACHUTING IS DANGEROUS. PARACHUTE SYSTEMS AND THEIR COMPONENTS SOMETIMES FAIL TO FUNCTION PROPERLY EVEN WHEN CORRECTLY ASSEMBLED, PACKED AND OPERATED. BEFORE YOU USE THIS PARACHUTE ASSEMBLY, YOU MUST FULLY UNDERSTAND AND ACCEPT THAT YOU RISK SERIOUS PERMANENT INJURY OR DEATH EACH TIME YOU USE THIS PARACHUTE ASSEMBLY. PROPER TRAINING AND EXPERIENCE ARE REQUIRED TO LOWER THE RISK OF SERIOUS PERMANENT INJURY OR DEATH.

ALSO, YOU MUST:

A. READ AND FULLY UNDERSTAND THIS WARNING LABEL, THE APPROPRIATE OWNERS MANUAL, SUPPLEMENTAL INFORMATION AND PACKING INSTRUCTIONS, FOLLOW ALL MANUFACTURERS' RECOMMENDATIONS (INCLUDING BUT NOT LIMITED TO WING LOADING RECOMMENDATIONS), AND ENSURE THAT YOU HAVE COMPLETED AN APPROPRIATE "CONTROLLED PROGRAM OF INSTRUCTION" IN THE USE OF THIS PARACHUTE ASSEMBLY AND EACH OF ITS COMPONENTS.

OR

B. READ AND FULLY UNDERSTAND THIS WARNING LABEL, THE APPROPRIATE OWNERS MANUAL, SUPPLEMENTAL INFORMATION AND PACKING INSTRUCTIONS, FOLLOW ALL MANUFACTURERS' RECOMMENDATIONS (INCLUDING BUT NOT LIMITED TO MANUFACTURER'S WING LOADING RECOMMENDATIONS), AND HAVE COMPLETED AT LEAST 100 RAM AIR PARACHUTE JUMPS.

2. THE RISK OF DEATH, SERIOUS INJURY, CANOPY DAMAGE AND HARD OPENINGS MAY BE LOWERED BY STRICTLY COMPLYING WITH ALL MANUFACTURERS' RECOMMENDATIONS AND SAFE PARACHUTING PRACTICES AND BY NEVER EXCEEDING THE LIMITS OF YOUR EXPERIENCE LEVEL AND THE MAXIMUM EQUIPMENT LIMITS, INCLUDING THE MAXIMUM LIMITS FOR THIS HARNESS/CONTAINER OF:

a. Maximum Exit Weight (weight of jumper + clothing + equipment): 136 Kg (300 pounds)  
b. Maximum Opening Velocity: 150 Knots (172 mph)

PRIOR TO ASSEMBLY, PACKING OR USE OF THIS PRODUCT, READ AND FULLY UNDERSTAND THE CONTENT AND ALL WARNINGS CONTAINED IN THIS MANUAL, AND CAREFULLY FOLLOW ALL INSTRUCTIONS BEFORE AND DURING PACKING AND USING THE PARACHUTE SYSTEM

## 1.4 TECHNICAL SPECIFICATIONS AND LIMITATIONS

### SPECIFICATIONS: THE ICON HARNESS CONTAINER IS CERTIFIED UNDER TSO C23d

It is produced in different sizes in accordance to the TSO C23d SMART range of canopies.

RESERVE CANOPY USE: Must be used with TSO certified reserve canopies.

ICON container sizes:

SIZE	SMART Reserve	Reserve size range	Main canopy	Main size range
I1	99	252in <sup>3</sup> . min-262in <sup>3</sup> . max	90-96	304in <sup>3</sup> . min-311in <sup>3</sup> . max
I2	99-110	262in <sup>3</sup> . min-275in <sup>3</sup> . max	96-111	304in <sup>3</sup> . min-327in <sup>3</sup> . max
I3	110-120	275in <sup>3</sup> . min-333in <sup>3</sup> . max	117-132	340in <sup>3</sup> . min-368in <sup>3</sup> . max
I4	135-150	333in <sup>3</sup> . min-346in <sup>3</sup> . max	132-150	368in <sup>3</sup> . min-393in <sup>3</sup> . max
I5	150-175	346in <sup>3</sup> . min-384in <sup>3</sup> . max	150-168	393in <sup>3</sup> . min-416in <sup>3</sup> . max
I6	175-190	384in <sup>3</sup> . min-476in <sup>3</sup> . max	168-190	416in <sup>3</sup> . min-465in <sup>3</sup> . max
I7	190-250	476in <sup>3</sup> . min-488in <sup>3</sup> . max	210-250	486in <sup>3</sup> . min-556in <sup>3</sup> . max
S7	190-250	476in <sup>3</sup> . min-488in <sup>3</sup> . max	230-250	486in <sup>3</sup> . min-556in <sup>3</sup> . max
S8	220-250	476in <sup>3</sup> . min-488in <sup>3</sup> . max	250-270	507in <sup>3</sup> . min-597in <sup>3</sup> . max
S9	220-250	476in <sup>3</sup> . min-488in <sup>3</sup> . max	250-290	597in <sup>3</sup> . min-673in <sup>3</sup> . max

ICON Harness size: The Icon Harness is produced in the following sizes:

A= XX-Special  
 B= X-Small  
 C= Small  
 D= Medium

E= Large  
 F= X-Large  
 G= XX-Large  
 H= XXX-Large

### LIMITATIONS:

**MAXIMUM SPEED: 150 KTS**

**MAXIMUM WEIGHT IS DEFINED BY THE LOWER OF THE TWO: 136 KG OR THE RESERVE CANOPY TSO MAXIMUM WEIGHT**

### QUALIFIED RESERVE DEPLOYMENT SYSTEM:

**FREEBAG WITH SPRING PILOT CHUTE PACKING: AS SPECIFIED IN THIS MANUAL.**

### MAIN DEPLOYMENT SYSTEM:

**DEPLOYMENT BAG WITH HAND DEPLOYED PILOT CHUTE OR STATIC LINE.**

PRIOR TO ASSEMBLY, PACKING OR USE OF THIS PRODUCT, READ AND FULLY UNDERSTAND THE CONTENT AND ALL WARNINGS CONTAINED IN THIS MANUAL, AND CAREFULLY FOLLOW ALL INSTRUCTIONS BEFORE AND DURING PACKING AND USING THE PARACHUTE SYSTEM

### 1.5 Major Components & Accessories:

Main cutaway handle with rigid puff



Reserve handle with rigid puff or metallic handle

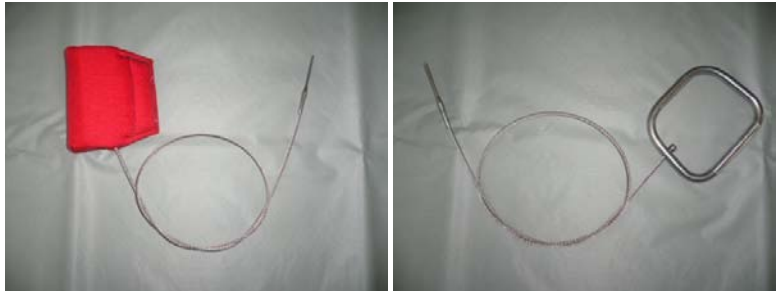

RSL



Miniforce™ Type 17 risers with toggles



Main cutaway handle position



Reserve handle position



Pilot Chute with hacky sack deploy and collapsible bridle.



LEGSTRAPS



PRIOR TO ASSEMBLY, PACKING OR USE OF THIS PRODUCT, READ AND FULLY UNDERSTAND THE CONTENT AND ALL WARNINGS CONTAINED IN THIS MANUAL, AND CAREFULLY FOLLOW ALL INSTRUCTIONS BEFORE AND DURING PACKING AND USING THE PARACHUTE SYSTEM

## 2 ASSEMBLY AND OPERATING INSTRUCTIONS

### 2.1 INSPECTION BEFORE PACKING AND ASSEMBLY

1. Read and understand this manual and be qualified by proper instruction for sport parachuting activities.
2. Ensure that the reserve and main canopy size is compatible with the harness-container and deployment system with which it is to be used.
3. Prior to assembly and/or packing a thorough inspection of the ICON Harness and container must be completed.
  - Reserve container
  - Main container
  - Harness
  - All cable housings
  - All stitching
  - All grommets
  - Reserve handle integrity and correct size fitted
  - Cut away housing integrity
  - Reserve risers and toggle deployment system

Take note of any worn, damaged, corroded or incorrectly rigged components, which must be repaired or replaced before the harness container is packed for use.

## 2.2 SOFT LINKS ASSEMBLY

Soft Link for reserve canopies.

PN: P 1487-01

Installation Procedure on front and rear main and reserve risers:

Soft Link for Main canopies on miniforce risers.

PN: P 1487-00

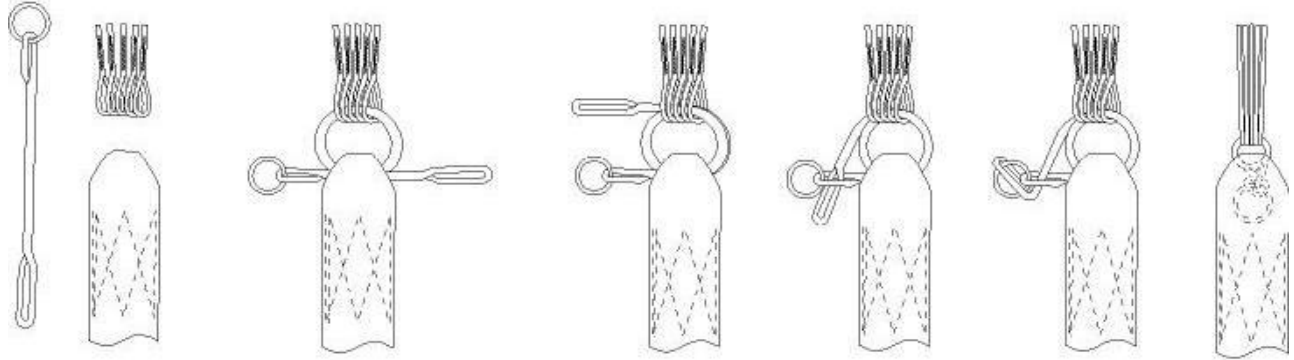

Secure the Soft Link ring in the webbing pocket, and hand tack as shown.

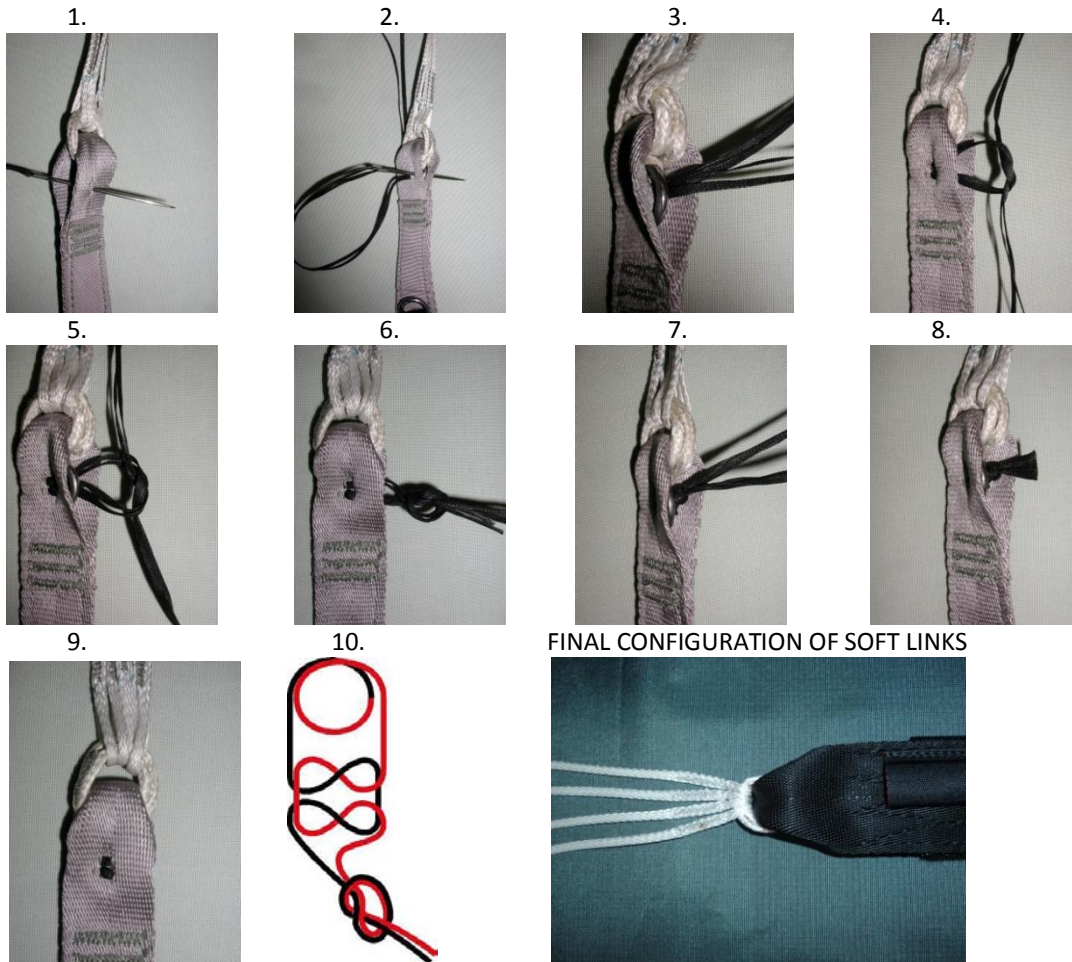

PRIOR TO ASSEMBLY, PACKING OR USE OF THIS PRODUCT, READ AND FULLY UNDERSTAND THE CONTENT AND ALL WARNINGS CONTAINED IN THIS MANUAL, AND CAREFULLY FOLLOW ALL INSTRUCTIONS BEFORE AND DURING PACKING AND USING THE PARACHUTE SYSTEM

## 2.3 AAD INSTALLATION PROCEDURES

### 2.3.1 CYPRES INSTALLATION (NON-SKYHOOK)

Insert the Cypres unit into the spandex pocket.

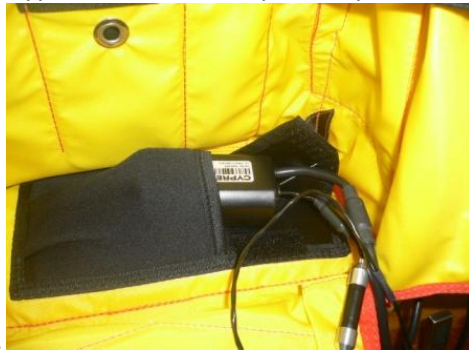

1.



2.

Route the Cypres Control unit through the Back pad.



3.



4.

Insert the control unit in the Back pad window.

Insert the cutter through the proper routing.



5.



6.

Align the cutter hole with that of the closing flap.



7.



8.

PRIOR TO ASSEMBLY, PACKING OR USE OF THIS PRODUCT, READ AND FULLY UNDERSTAND THE CONTENT AND ALL WARNINGS CONTAINED IN THIS MANUAL, AND CAREFULLY FOLLOW ALL INSTRUCTIONS BEFORE AND DURING PACKING AND USING THE PARACHUTE SYSTEM

2.3.1.1 ALTERNATE CYPRESS CUTTER INSTALLATION  
(SKYHOOK CYPRESS INSTALLATION)

Install the CYPRESS Main and Control unit as shown in section 2.3.1. The alternate cutter routing places the cutter above the pilot chute. Insert the cutter through the slit in flap #1 (picture #10).



Then route the cutter through the tunnel in flap #2 (#3, SKYHOOK) as shown in pictures #11 & #12.



Finally insert the cutter through the elastic and align the hole with the grommet in flap #2 (#3, SKYHOOK).



**NOTE:** REFER TO THIS SECTION (2.3.1.1) FOR THE SKYHOOK SYSTEM, WHICH HAS BEEN DESIGNED WITH THE CYPRESS INSTALLED IN THIS LOCATION.

PRIOR TO ASSEMBLY, PACKING OR USE OF THIS PRODUCT, READ AND FULLY UNDERSTAND THE CONTENT AND ALL WARNINGS CONTAINED IN THIS MANUAL, AND CAREFULLY FOLLOW ALL INSTRUCTIONS BEFORE AND DURING PACKING AND USING THE PARACHUTE SYSTEM



### 2.3.2 FXC INSTALLATION

Install the Power Cable and Housing as shown.



Secure the Power Cable End Fitting with a Housing Bracket



Insert Mechanism into pocket.

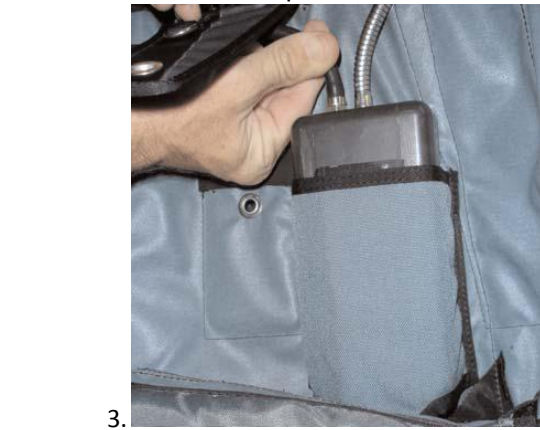

Stow Air Hose.



Fit Altitude Control Unit and stow Air Hose.



PRIOR TO ASSEMBLY, PACKING OR USE OF THIS PRODUCT, READ AND FULLY UNDERSTAND THE CONTENT AND ALL WARNINGS CONTAINED IN THIS MANUAL, AND CAREFULLY FOLLOW ALL INSTRUCTIONS BEFORE AND DURING PACKING AND USING THE PARACHUTE SYSTEM

Place Air Hose as Shown



Place RSL over the Air Hose.



Place Reserve Risers. Ensure Risers are clear from Air Hose.



RSL and Pin arrangement.

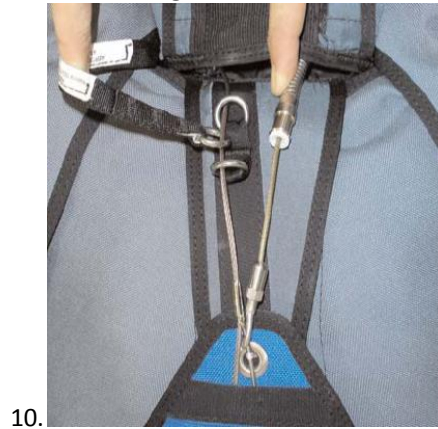

Close Reserve Top Flap



PRIOR TO ASSEMBLY, PACKING OR USE OF THIS PRODUCT, READ AND FULLY UNDERSTAND THE CONTENT AND ALL WARNINGS CONTAINED IN THIS MANUAL, AND CAREFULLY FOLLOW ALL INSTRUCTIONS BEFORE AND DURING PACKING AND USING THE PARACHUTE SYSTEM

## 2.4 RESERVE ASSEMBLY

### 2.4.1 CONNECTING THE CANOPY TO THE CONTAINER

Connect front lines to the front risers. Pass the lines through the front slider grommets. For connection see section 2.2.

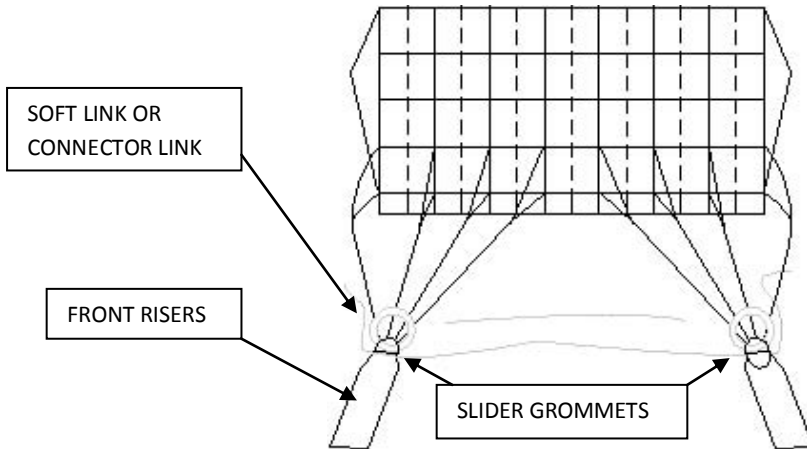

Connect rear lines. Pass the line through the rear slider grommets. For connection see section 2.2.

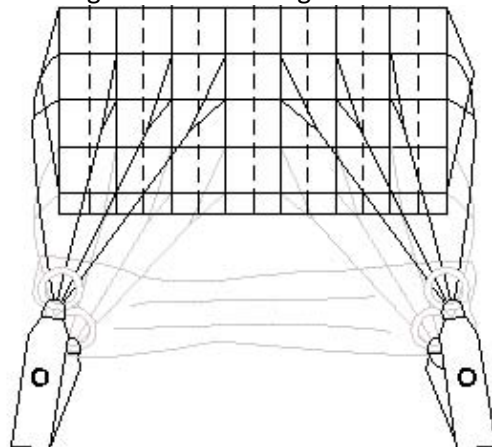

Connect the steering lines. Pass the steering lines through the rear slider grommet and through the guide ring on the rear reserve riser. For assembly of steering toggle see section 2.4.2.

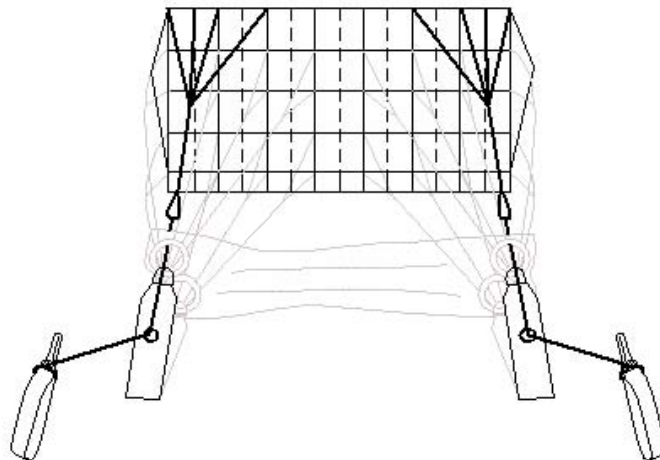

PRIOR TO ASSEMBLY, PACKING OR USE OF THIS PRODUCT, READ AND FULLY UNDERSTAND THE CONTENT AND ALL WARNINGS CONTAINED IN THIS MANUAL, AND CAREFULLY FOLLOW ALL INSTRUCTIONS BEFORE AND DURING PACKING AND USING THE PARACHUTE SYSTEM

### 2.4.2 RESERVE TOGGLE ASSEMBLY

Pass the lower steering line through the rear riser guide ring.

Pass the line through the toggle grommet and loop around the toggle. Pull tight.

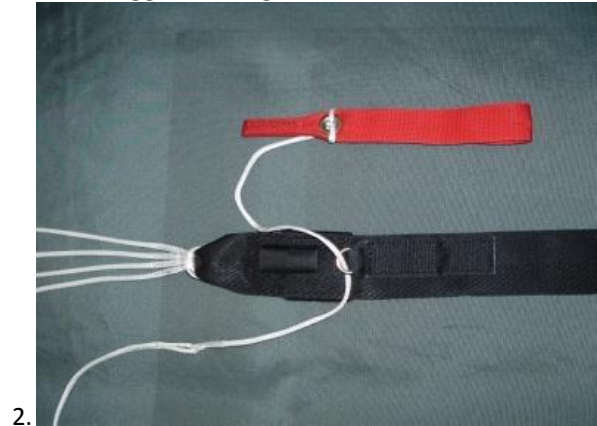
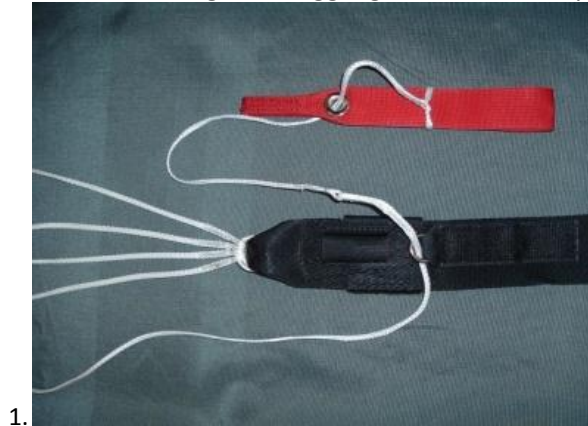

Set the toggle into the lower steering line break loop. Slide the toggle finger into the pocket. Stow the extra line and close the Velcro. Fix and secure the toggle on the rear riser.

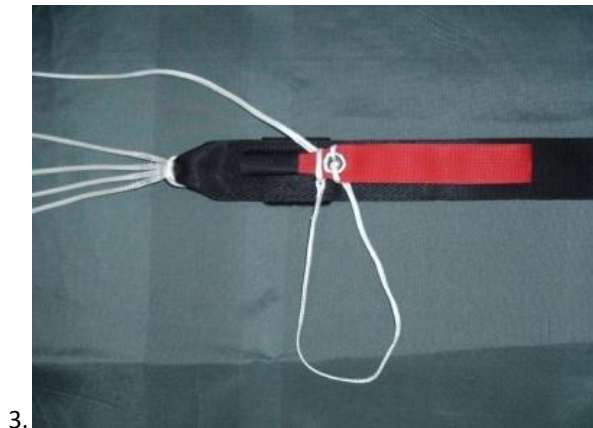

2.4.3 RESERVE CLOSURE LOOP ASSEMBLY

**MANDATORY:** Only use the provided Cypres closure loop with the Icon Harness and Container!

To set the reserve closure loop and washer use the following method as shown.



Adjust the length to the specifications below and tighten the knot.

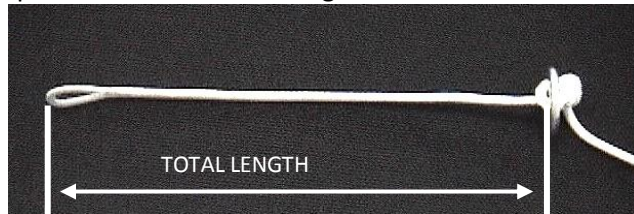

Measurement in centimeters (cm)

	ICON 1	ICON 2	ICON 3	ICON 4	ICON 5	ICON 6	ICON 7	ICON 8	ICON 9
SMART 99	12.0	12.0							
SMART 110		13.0	11.0						
SMART 120			12.0	11.0					
SMART 135				12.0					
SMART 150				13.0	12.0				
SMART 160					13.0				
SMART 175					14.0	14.0			
SMART 190						14.0	14.0		
SMART 220							14.5	14.5	14.5
SMART 250							15.0	15.0	15.0

PRIOR TO ASSEMBLY, PACKING OR USE OF THIS PRODUCT, READ AND FULLY UNDERSTAND THE CONTENT AND ALL WARNINGS CONTAINED IN THIS MANUAL, AND CAREFULLY FOLLOW ALL INSTRUCTIONS BEFORE AND DURING PACKING AND USING THE PARACHUTE SYSTEM

#### 2.4.4 PACKING THE RESERVE CANOPY

For packing of the Reserve container, follow the Reserve canopy manufacturer's WARNINGS, instructions and recommendations.

For the closing of the Reserve Container follow the Icon Manuals WARNINGS, instructions and recommendations.

**NOTE:** Packing of the Reserve Canopy and Container must be completed by a qualified rigger. When packing the reserve, minimize fabric in the center of bag so that a nest is built for the pilot chute to sit into (see picture# 4 on section 2.4.6).

#### 2.4.5 STOWING THE RESERVE LINES

Position Freebag as shown (#1). Place first stow in elastic keeper at bottom (#2), opposite side to last locking stow at opening of Freebag. Stows should not extend more than 1 inch (2.5cm) beyond the elastic keeper.



Place the next stow in the opposite side bottom elastic. Continue from side to side until you have placed the last stow in the last available elastic keeper at the top of the Freebag.



PRIOR TO ASSEMBLY, PACKING OR USE OF THIS PRODUCT, READ AND FULLY UNDERSTAND THE CONTENT AND ALL WARNINGS CONTAINED IN THIS MANUAL, AND CAREFULLY FOLLOW ALL INSTRUCTIONS BEFORE AND DURING PACKING AND USING THE PARACHUTE SYSTEM

Leave enough excess line to allow the risers to lay flat under the Freebag to the outside edge of the pack tray.



**NOTICE TO RIGGER:** FOR PACKING OF THE SKYHOOK SYSTEM RESERVE, PLEASE REFER TO THE ADDENDUM ON PAGE 40 OF THIS MANUAL. FAILURE TO FOLLOW THIS NOTICE WILL RESULT IN DEATH OR SERIOUS INJURY.

PRIOR TO ASSEMBLY, PACKING OR USE OF THIS PRODUCT, READ AND FULLY UNDERSTAND THE CONTENT AND ALL WARNINGS CONTAINED IN THIS MANUAL, AND CAREFULLY FOLLOW ALL INSTRUCTIONS BEFORE AND DURING PACKING AND USING THE PARACHUTE SYSTEM

### 2.4.6 PACKING THE RESERVE CONTAINER (NON-SKYHOOK ONLY)

Prepare the Freebag shape as shown.



Side view and Top view.

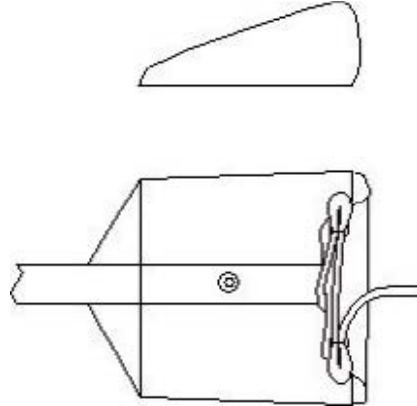

Set up the rig as shown before packing.

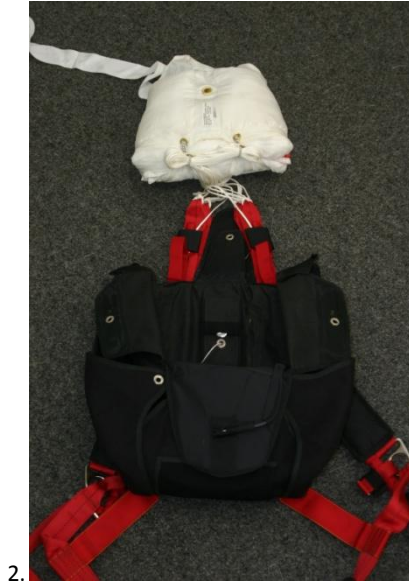

Lay the risers flat against the container wall.



Place the Freebag and pass the closure loop through the Freebag's central grommet (picture# 3). Push and compress the lower corners of the Freebag into the reserve container (see arrows picture# 4). Make sure to nest the Freebag.

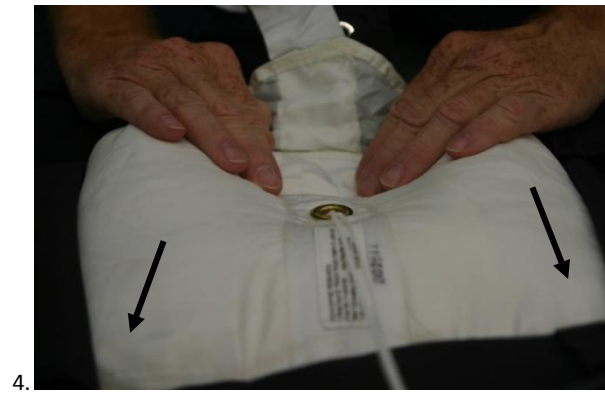

PRIOR TO ASSEMBLY, PACKING OR USE OF THIS PRODUCT, READ AND FULLY UNDERSTAND THE CONTENT AND ALL WARNINGS CONTAINED IN THIS MANUAL, AND CAREFULLY FOLLOW ALL INSTRUCTIONS BEFORE AND DURING PACKING AND USING THE PARACHUTE SYSTEM



Fold the reserve bridle as shown (3 folds on each side, picture# 5). Place the kicker plate (#1 flap) over the Freebag and fold the remaining bridle in a triangle shape around the grommet (picture# 6).



5.



6.

Pass a pull up cord cleanly through the pilot chute from bottom to top plate (picture# 7). Ensure the lower spring coil is up against the spring ejector plate and that the excess bridle sits just under the pilot chute without catching the fabric under the spring.



7.



8.

Press the pilot chute down into position and hold with a temporary pin. Make sure not to catch the pilot chute fabric under the plate. Also, do not tuck the pilot chute under the lateral flaps (#2 and #3 flaps) but instead roll it up in between both pilot chute plates (pictures# 9 & 10).



9.



10.

PRIOR TO ASSEMBLY, PACKING OR USE OF THIS PRODUCT, READ AND FULLY UNDERSTAND THE CONTENT AND ALL WARNINGS CONTAINED IN THIS MANUAL, AND CAREFULLY FOLLOW ALL INSTRUCTIONS BEFORE AND DURING PACKING AND USING THE PARACHUTE SYSTEM

Close the right flap (#2)



Close the left flap (#3).



Close the top flap (#4). Close the bottom flap (#5). Install the reserve cable making sure it passes through both rings on the #5 flap.



Close the final cover flap and tuck the tabs under the #5 flap.



PRIOR TO ASSEMBLY, PACKING OR USE OF THIS PRODUCT, READ AND FULLY UNDERSTAND THE CONTENT AND ALL WARNINGS CONTAINED IN THIS MANUAL, AND CAREFULLY FOLLOW ALL INSTRUCTIONS BEFORE AND DURING PACKING AND USING THE PARACHUTE SYSTEM

### 2.4.7 RSL INSTALLATION (NON-SKYHOOK ONLY)

**NOTE:** For Skyhook applications follow the Skyhook instructions on page 34 of this manual. If system has an RSL, follow these steps to properly attach the lanyard.

Install the reserve handle making sure the cable passes thru both guide rings on the #5 flap. Install the RSL passing the reserve cable through the ring attached to the lanyard as shown in picture #17.



16.



17.

Verify the reserve handle pull force is between a minimum of 5 lbs (22.2 Newtons) and a maximum of 22 lbs. (97.9 Newtons).



18.

PRIOR TO ASSEMBLY, PACKING OR USE OF THIS PRODUCT, READ AND FULLY UNDERSTAND THE CONTENT AND ALL WARNINGS CONTAINED IN THIS MANUAL, AND CAREFULLY FOLLOW ALL INSTRUCTIONS BEFORE AND DURING PACKING AND USING THE PARACHUTE SYSTEM

## 2.5 MAIN ASSEMBLY

2.5.1 SOFT LINKS ASSEMBLY: Assemble the main canopy's soft link as previously explained for the reserve canopy (section 2.4.1).

### 2.5.2 MAIN TOGGLE ASSEMBLY

Miniforce risers Pin & Toggle



Pass the steering line through the guide ring and connect the toggle to the steering line as shown.



Insert the toggle into its pocket and lock the bottom pin



Stow the excess line in the keepers behind the riser.



PRIOR TO ASSEMBLY, PACKING OR USE OF THIS PRODUCT, READ AND FULLY UNDERSTAND THE CONTENT AND ALL WARNINGS CONTAINED IN THIS MANUAL, AND CAREFULLY FOLLOW ALL INSTRUCTIONS BEFORE AND DURING PACKING AND USING THE PARACHUTE SYSTEM



6.

### 2.5.3 MINIFORCE™ THREE RING RISER INSTALLATION

Left hand side.



1.

Right hand side



2.

Side View



3.

Insert the cutaway cable into the Anti-twist Housing.



### 2.5.4 MAIN DEPLOYMENT & D-BAG ASSEMBLY

Remove the link from the end of the bridle line and thread the end loop through the D-bag's bottom grommet from the outside until it stops with the confluence wrap. Make sure to pull into the D-bag as much as possible to facilitate installing the Rapide link.



Secure the bridle with the Rapide link. Make sure that the kill line is inside the link (picture #3), and that the link passes through both loops on the end of the confluence wrap.



Next thread the end loop of the bridle through the canopy's attachment point (picture #5), then thread the pilot chute and D-bag through the bridle's end loop and tighten as shown.



PRIOR TO ASSEMBLY, PACKING OR USE OF THIS PRODUCT, READ AND FULLY UNDERSTAND THE CONTENT AND ALL WARNINGS CONTAINED IN THIS MANUAL, AND CAREFULLY FOLLOW ALL INSTRUCTIONS BEFORE AND DURING PACKING AND USING THE PARACHUTE SYSTEM



8.



9.

Pull the pilot chute to assure it is cocked. Make sure green mark shows at the bottom of the bridle window



7.



8.

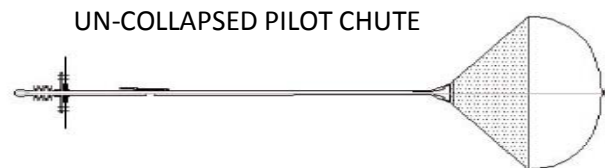
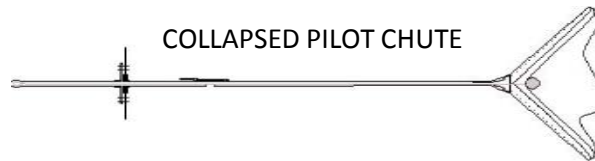

PRIOR TO ASSEMBLY, PACKING OR USE OF THIS PRODUCT, READ AND FULLY UNDERSTAND THE CONTENT AND ALL WARNINGS CONTAINED IN THIS MANUAL, AND CAREFULLY FOLLOW ALL INSTRUCTIONS BEFORE AND DURING PACKING AND USING THE PARACHUTE SYSTEM

Main assembly before closing the main container

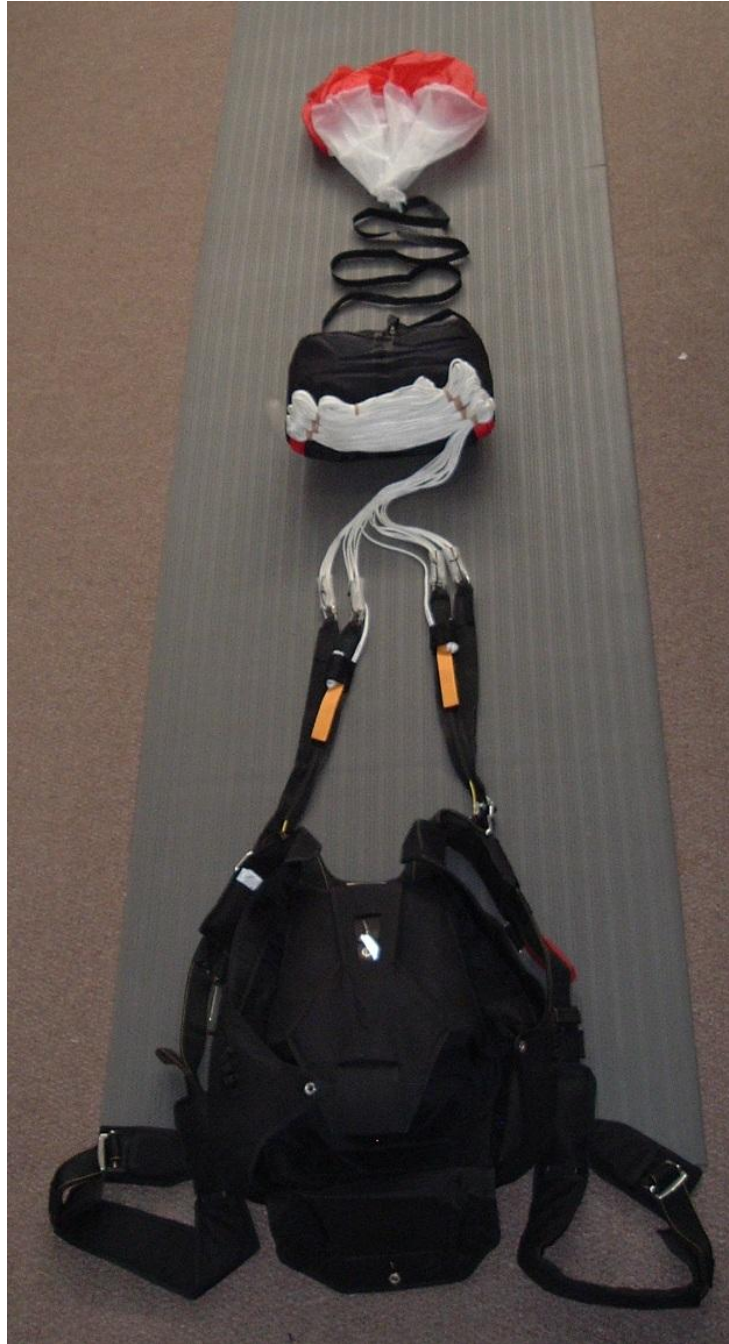

PRIOR TO ASSEMBLY, PACKING OR USE OF THIS PRODUCT, READ AND FULLY UNDERSTAND THE CONTENT AND ALL WARNINGS CONTAINED IN THIS MANUAL, AND CAREFULLY FOLLOW ALL INSTRUCTIONS BEFORE AND DURING PACKING AND USING THE PARACHUTE SYSTEM



### 2.5.5 PACKING THE MAIN CONTAINER

Place the main risers along sidewalls inside external riser covers. If internal riser covers are present, place risers under the internal riser covers (picture #1). Tuck the top riser cover over the riser (picture #2).



1.



2.

Close the cover by inserting the tab into the pocket



3.

Press tight to correct position.



4.

PRIOR TO ASSEMBLY, PACKING OR USE OF THIS PRODUCT, READ AND FULLY UNDERSTAND THE CONTENT AND ALL WARNINGS CONTAINED IN THIS MANUAL, AND CAREFULLY FOLLOW ALL INSTRUCTIONS BEFORE AND DURING PACKING AND USING THE PARACHUTE SYSTEM

Place the main deployment bag in the pack tray with the lines facing down. At this stage, adjust the main closure loop length to suit the main canopy size.



**WARNING: For safety assurance, the minimum force exerted by the bridle on the curved pin must not be less than 4 daN or more than 6 daN.**

5. Adjust the closure loop length by moving the knot (picture# 6). Pull closure loop into position with the pull up cord. Place the washer and knot in the webbing pocket (picture# 7).



6. Pass the closure loop through the lower flap (#1), followed by the upper flap (#2).



PRIOR TO ASSEMBLY, PACKING OR USE OF THIS PRODUCT, READ AND FULLY UNDERSTAND THE CONTENT AND ALL WARNINGS CONTAINED IN THIS MANUAL, AND CAREFULLY FOLLOW ALL INSTRUCTIONS BEFORE AND DURING PACKING AND USING THE PARACHUTE SYSTEM

Pass the closing loop through the grommet on the right side flap (#3), making sure the bridle is exiting from the top right of the flap (picture #10). Pass the closing loop through the grommet on the left side flap (#4), and insert the closing pin. Verify the mark on the kill line is visible in the window to confirm that the pilot chute is cocked (picture #11).



### 2.5.6 Folding the Pilot Chute

Insure that the center line of the hand deploy pilot chute is free. Fold the hand deploy as shown.



PRIOR TO ASSEMBLY, PACKING OR USE OF THIS PRODUCT, READ AND FULLY UNDERSTAND THE CONTENT AND ALL WARNINGS CONTAINED IN THIS MANUAL, AND CAREFULLY FOLLOW ALL INSTRUCTIONS BEFORE AND DURING PACKING AND USING THE PARACHUTE SYSTEM



Close the main cover flap and slide the remaining bridle under the right lateral flap (#3).

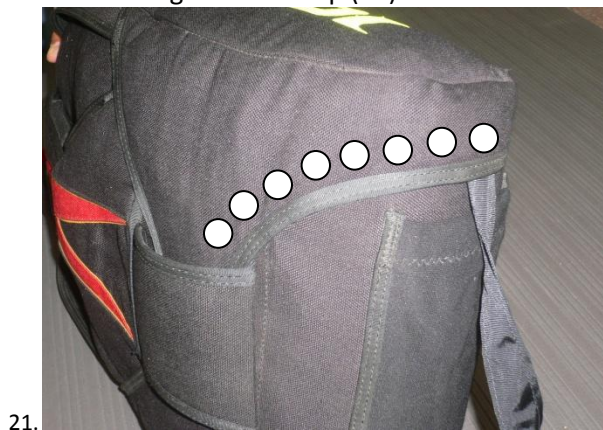
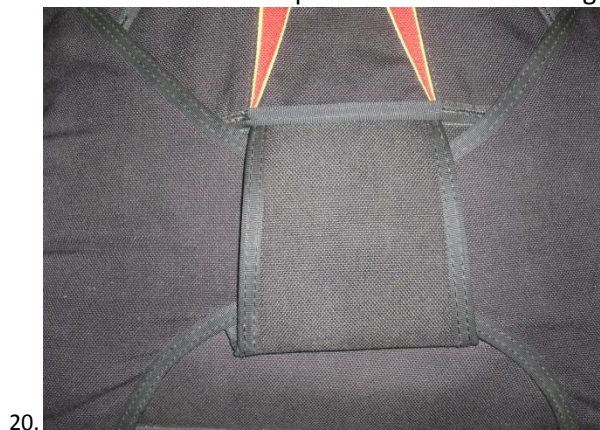

Free Fly Handle Procedures

Insert the pilot chute into the BOC.



Insert the free tab into the BOC.



Insert the other tab under the right lateral flap. #3

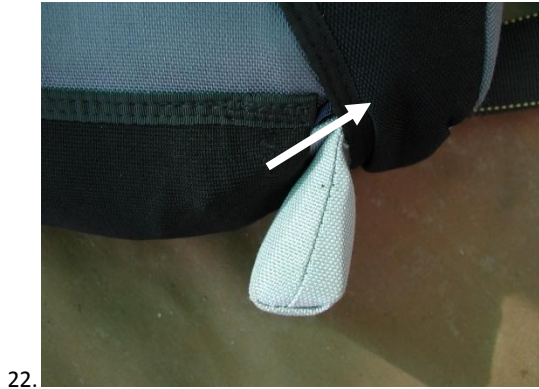

CRW Bridle Procedures

Routing of CRW Bridle on CRW Canopy (picture# 24). Routing of CRW bridle through deployment bag.



24.



25.

Note position of closing pin (picture# 26). Pack canopy into D-bag as described in manual and close the container as explained. Note pin location (picture#27).

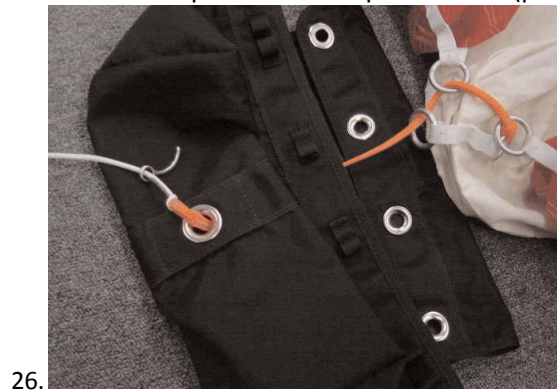

26.

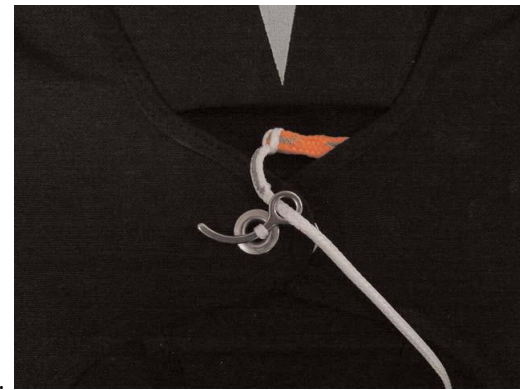

27.

Stow Pilot chute and remaining CRW bridle as stated.



28.

PRIOR TO ASSEMBLY, PACKING OR USE OF THIS PRODUCT, READ AND FULLY UNDERSTAND THE CONTENT AND ALL WARNINGS CONTAINED IN THIS MANUAL, AND CAREFULLY FOLLOW ALL INSTRUCTIONS BEFORE AND DURING PACKING AND USING THE PARACHUTE SYSTEM

### 3 ICON MAINTENANCE & REPAIRS

The ICON is built with the latest design and production technologies.

Qualified personnel:

All maintenance on the ICON Harness & Container must be done by the Manufacturer or a qualified rigger.

Attention:

The ICON is certified under TSO C23d. The TSO label is sewn on the left reserve riser. If this label is not present do not pack the rig.

**REMOVAL OF THE CERTIFICATION OR WARNING LABEL VOIDS THE TSO AND ALL CERTIFICATION APPROVALS.**

#### 3.1 INSPECTION FREQUENCY

RESERVE:

Reserve maintenance and packing: Verify local regulations on reserve canopy maintenance. If none are available, follow these recommendations. Service the reserve canopy at 1 year intervals in normal conditions of use and storage. If the conditions are different, the time between maintenance operations may be reduced by the user.

MAIN:

One month or 50 jumps.

#### 3.2 MAINTENANCE PROCEDURE

Operations on the reserve container:

WARNING:

A reserve canopy is not always used in ideal conditions. It is possible that your rig or some components are damaged during use (Burns, broken stitching, moisture, etc.). For these reasons it is necessary to check all the minor and major components before making a decision to reuse and repack it.

**IF THERE ARE ANY VISIBLE SIGNS OF WEAR OR DAMAGE, HAVE YOUR RIG INSPECTED BY A QUALIFIED RIGGER FOR ADVICE ON REPAIR OR REPLACEMENT OF PARTS.**

**WARNING: NEVER USE SLIDER BUMPERS ON THE RESERVE CANOPY**

PRIOR TO ASSEMBLY, PACKING OR USE OF THIS PRODUCT, READ AND FULLY UNDERSTAND THE CONTENT AND ALL WARNINGS CONTAINED IN THIS MANUAL, AND CAREFULLY FOLLOW ALL INSTRUCTIONS BEFORE AND DURING PACKING AND USING THE PARACHUTE SYSTEM

**CHECK:**

- All stitching
- Webbing – tapes – binding tapes – fabric integrity
- Plastic plate integrity
- Hardware for sharp edges or damage
- Grommets for damage

**ACCESSORIES:**

- CYPRESS reserve closure loop replaced as needed
- Cut away handle cables are clean and in good condition with no damage to cable coating

**Cutaway cable maintenance:**

- Use clean cloth and wipe away cables with silicone spray.
  - Thread back through housings, remove, clean
  - Repeat until cutaway cables can be removed clean.
- 
- Reserve handle for no sharp edges and swaging is in good condition
  - Reserve Freebag stitching and grommets. Replace shock cord if damaged
  - Reserve bridle is in good condition
  - Reserve pilot chute fabric, spring attachment & condition

**OPERATIONS ON THE MAIN RIG EVERY 50 JUMPS**

**INSPECTION OF ALL COMPONENTS**

**HARNESS CONTAINER CHECK:**

- All stitching
- Webbing – tapes – binding tapes – fabric integrity
- Plastic plate integrity
- Hardware for sharp edges or damage
- Grommets for damage
- Replace main closure loop with new

**ACCESSORIES:**

- Main D-bag stitching, tapes and change rubber stowing bands
  - Main bridle & kill line stitching and kill line condition
  - Hand deploy pilot chute stitching, mesh & fabric condition
  - Main risers and three ring miniforce system
  - Toggle's stitching and pin
- Miniforce™ three ring maintenance: release the three ring system every 50 jumps and knead the webbing as shown.



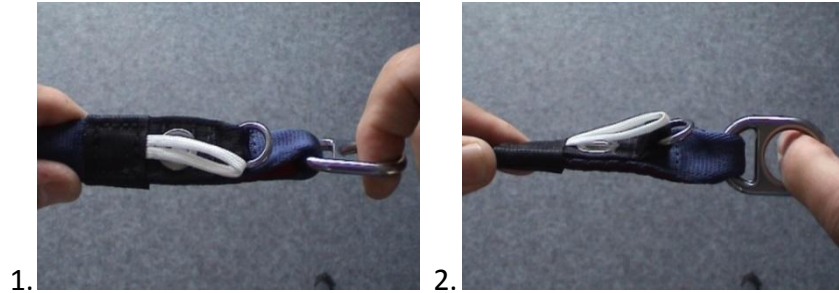

### 3.3 STORAGE AND USE:

Textile (polyamides) and other materials (hardware) used in the construction of all parachutes are sensitive to the following environmental elements:

- Acids (car battery)
- Abrasion
- Chlorine
- Excessive heat 93°C or higher
- OIL and grease (polyamides)
- Rodents and pests
- Salt water
- Smoke
- UV rays (sun)
- Water and humidity

When the parachute is not in use it must be placed in a carry bag and stored in a room where the temperature is between 15 and 30 degrees Celsius and the humidity between 15% and 70%.

### 3.4 USER CHECKLIST BEFORE JUMP

- Verify the packing date on the data-card
- Reserve handle in its pocket, and the correct cable routing without tension
- Turn automatic opener (AAD) "ON"
- Cut away handle in its pocket and cable routing correctly into housings
- Correct setting of the 3-Ring system and loop condition
- Harness main webbing and leg webbing stitching.
- Hardware condition (no grease, no corrosion)
- Main and reserve closure loop condition
- Hand deploy pilot chute bridle routing
- Curved pin extraction force not over 6kg/12lbs
- Hand deploy handle in correct position

When putting rig on back make sure that the harness and leg webbing is not twisted.

Check position and ease of access of:

- Main hand deploy handle
- Cutaway handle
- Reserve handle

## 4 SKYHOOK ADDENDUM



### 4.1 SETTING UP THE SKYHOOK RSL LANYARD

- White Ripcord Lanyard
- Red Skyhook Lanyard
- RSL Lanyard



1. Loop the Red Lanyard through the open loop on the RSL. Notice not to loop it through the labeled loop for the Cutaway cable. Repeat with the White Lanyard. Careful not to catch the Velcro onto the lanyard itself. To avoid this, slightly bend the Velcro parallel to the lanyard and pull in one quick but gentle motion.

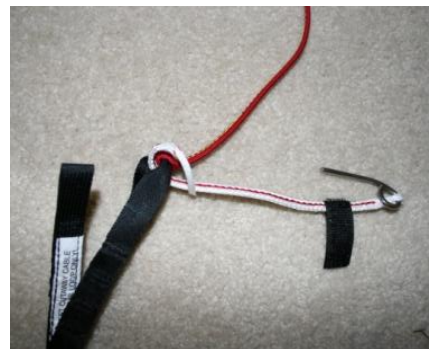

2. Place the RSL on the right riser and attach via Velcro routing. Then insert the Red Lanyard into its designated tuck tab on flap 2A. Tuck end into pocket on yoke near top of right D-ring.



PRIOR TO ASSEMBLY, PACKING OR USE OF THIS PRODUCT, READ AND FULLY UNDERSTAND THE CONTENT AND ALL WARNINGS CONTAINED IN THIS MANUAL, AND CAREFULLY FOLLOW ALL INSTRUCTIONS BEFORE AND DURING PACKING AND USING THE PARACHUTE SYSTEM

3. Insert the left cutaway cable through the labeled loop on the RSL (reserved for the cutaway cable). Next attach the Velcro on the white lanyard to flap #5. **CAUTION:** Verify routing of AAD cables not to be entangled in any way with the RSL.

#### 4.2 CLOSING THE RESERVE

1. Insert the reserve closing loop through the reserve grommets. Install staging loop through the bottom grommet by reaching in between the backpad and reserve container (staging loop should be 1" (25.4mm) shorter than the Cypress loop and should only pass through the bottom grommet not covered by the elastic).

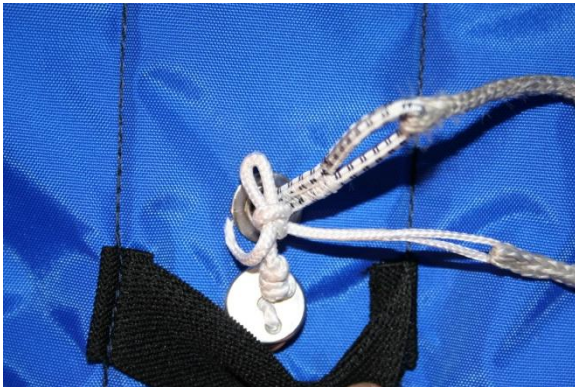

3. Looking at the container from the top of the reserve tray, route the reserve closing loop through the center grommet and the staging loop through the offset grommet on the right.



4. Secure the reserve closing loop with a temporary pin. Fold the Freebag bridle over the staging loop and insert about an inch through the staging loop.



2. Place the Freebag onto the container and with two pull up cords pull the closing and hesitator loops through the grommets on the freebag.



PRIOR TO ASSEMBLY, PACKING OR USE OF THIS PRODUCT, READ AND FULLY UNDERSTAND THE CONTENT AND ALL WARNINGS CONTAINED IN THIS MANUAL, AND CAREFULLY FOLLOW ALL INSTRUCTIONS BEFORE AND DURING PACKING AND USING THE PARACHUTE SYSTEM

5. With staging loop in place, V-fold the remainder of bridle under Flap #1. Fold to point where the green loop lies at the edge of the reserve container. Make sure to have enough slack for bridle to fold over flap #2A.



6. Hold the remaining bridle in place; you may use a paddle if helpful. Then close flap #2A and lock with temporary closing pin. Insert the green loop into green tuck tab on flap #2A.



7. Lay the Skyhook bridle over flap #2A. Attach the Red Lanyard to the Skyhook and secure with red seal thread by passing thread through the 2 holes in plastic cover.



PRIOR TO ASSEMBLY, PACKING OR USE OF THIS PRODUCT, READ AND FULLY UNDERSTAND THE CONTENT AND ALL WARNINGS CONTAINED IN THIS MANUAL, AND CAREFULLY FOLLOW ALL INSTRUCTIONS BEFORE AND DURING PACKING AND USING THE PARACHUTE SYSTEM

- Now proceed to close flap #2B, hold in place with a pin and fold the remaining bridle on top of the reserve. Now compress the pilot chute onto the reserve and hold in place with a pin.



- Close flaps # 3, #4 and #5.



- Close flap #6 and insert the reserve closing pin (1) through the eye of the reserve cable first, (2) then through reserve closing loop. Make sure to tuck the closing pin under the protector pocket.

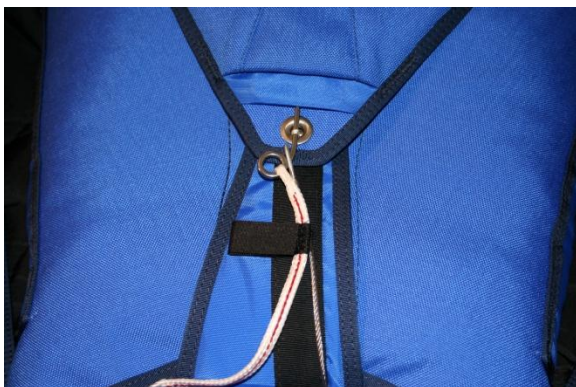

Proceed to seal and finish pack job as normal.

PRIOR TO ASSEMBLY, PACKING OR USE OF THIS PRODUCT, READ AND FULLY UNDERSTAND THE CONTENT AND ALL WARNINGS CONTAINED IN THIS MANUAL, AND CAREFULLY FOLLOW ALL INSTRUCTIONS BEFORE AND DURING PACKING AND USING THE PARACHUTE SYSTEM

<b>5 Maintenance Log</b>				
<b>Date</b>	<b>Done By</b>	<b>Job Description</b>		

PRIOR TO ASSEMBLY, PACKING OR USE OF THIS PRODUCT, READ AND FULLY UNDERSTAND THE CONTENT AND ALL WARNINGS CONTAINED IN THIS MANUAL, AND CAREFULLY FOLLOW ALL INSTRUCTIONS BEFORE AND DURING PACKING AND USING THE PARACHUTE SYSTEM